

**OPERATOR'S
&
PARTS MANUAL**

CENTRAL-VAC SYSTEM

Warranty Registration Form & Inspection Report

WARRANTY REGISTRATION (3 part form - please print)		
<i>This form must be filled out by the dealer and signed by both the dealer and the customer at the time of delivery.</i>		
<i>Delivery Date: mm / dd / yyyy</i>		
<i>COMPANY / CUSTOMER NAME</i>		<i>DEALER NAME</i>
<i>Phone:</i>		<i>Phone</i>
<i>Mobile phone:</i>		<i>Mobile phone</i>
<i>Email : @</i>		<i>Email : @</i>
<i>Street Address:</i>		<i>Street Address</i>
<i>City: Prov/State</i>		<i>City: Prov/State</i>
<i>Postal/Zip Country</i>		<i>Postal/Zip Country</i>
<i>Machine Serial Number</i>	<i>Blower Serial No.</i>	<i>Airlock Serial Number</i>

DEALER INSPECTION REPORT		SAFETY	
<input type="checkbox"/>	Blowers and Airlock Turn Freely	<input type="checkbox"/>	Guards Installed and Secured
<input type="checkbox"/>	Airline Connections Tight	<input type="checkbox"/>	All Safety Signs Installed
<input type="checkbox"/>	Airline Intake Caps Secured	<input type="checkbox"/>	Review Operating and Safety Instructions
<input type="checkbox"/>	Airlock Access Door Closed & Secured	<input type="checkbox"/>	Operating Manual Supplied
<input type="checkbox"/>	Drive Chains and Belts Tensioned and Aligned		
<input type="checkbox"/>	Lubricate Machine		
<input type="checkbox"/>	Check Oil Level in Reservoirs		
<input type="checkbox"/>	O-Rings in Place		

I have thoroughly instructed the buyer on the above described equipment which review included the Operator's Manual content, equipment care, adjustments, safe operation and applicable warranty policy.

Date _____ Dealer's Rep. Signature _____

The above equipment and Operator's Manual have been received by me and I have been thoroughly instructed as to care, adjustments, safe operation and applicable warranty policy.

Date _____ Owner's Signature _____

199 05042016

*3 Part Form
Please Print*

WHITE	YELLOW	PINK
WALINGA	DEALER	CUSTOMER

Walinga Inc.

Pneumatic Conveying System

Warranty Terms

Walinga Inc. is committed to providing a quality product that will meet or exceed your expectations for many years to come. Our warranty terms and our warranty claim process has been designed to ensure that each warranty claim will be resolved in an orderly, fair and timely manner.

The Warranty

Walinga Inc. ("Walinga") warrants that all new pneumatic products sold by Walinga Inc. will be free from defects in material and workmanship (the "Walinga Warranty").

Warranty Period

The warranty period for the Walinga Warranty shall expire on the date that is the earlier of: two (2) years after the date of delivery to the original customer; or upon the expiration of five hundred (500) hours of operation; whichever date comes first.

Limitations of and exclusions from the Walinga Warranty

- The Walinga Warranty applies to material and workmanship only.
- With respect to any component parts that are supplied or manufactured by others, the warranty coverage on such component parts will be strictly limited to the warranties of the manufacturers of such component parts.
- The Walinga Warranty shall only be for the benefit of the original purchaser of the pneumatic products.
- A Walinga Warranty may be transferable by the original purchaser to a third party for the balance of the warranty period then remaining, provided that Walinga consents in writing to such transfer of warranty.
- The Walinga Warranty is conditional upon proper storage, installation, use, maintenance, operation and compliance with any applicable recommendations of Walinga.

Warranty Claim Procedure

Should you encounter any difficulties with your unit within its warranty period, please contact your local Walinga dealer or sales representative, your local Walinga Service department or Walinga's Warranty Department to submit a warranty claim application.

To speak with a Walinga Warranty Coordinator, contact:

- Canada 1-888-WALINGA (ext 258)
International +1-519-824-8520 (ext 258)
Email – warranty.canada@walinga.com
- USA 1-800-466-1197 (ext 8)
Email – warranty.usa@walinga.com
- Australia 07-4634-7344
Email – mail@customvac.com.au

Required Warranty Claim information

The following information must be provided to Walinga in order for us to properly process and consider your warranty application:

- Customer name and contact information (email if available).
- The equipment serial number and/or Vehicle Identification Number (if applicable).
- Date of claimed failure.
- Equipment hours of operation.
- Details, description and photos (upon request) of the claimed failure and the corrective repairs attempted.

Warranty Conditions

- **Equipment must be registered within 30 days of being received by the buyer. It will be within the sole and unfettered discretion of Walinga as to whether it will honour its warranty on non-registered equipment.**

Warranty Conditions (continued)

- The buyer is responsible for promptly notifying Walinga of any defects to the equipment. The buyer is also responsible for making the equipment available to Walinga or its authorized repair facility for evaluation and repair.
- Prior to making any repairs or parts replacements, a warranty application and any estimated associated costs must be approved with the issuance of a claim number by an authorized Walinga representative. Undertaking any work prior to receiving warranty authorization may result in a partial or complete loss of warranty coverage.
- At Walinga's discretion, warranty repairs may be authorized to be completed at a repair facility convenient to the buyer. In such situations the estimated labour time must be approved by Walinga prior to undertaking any work. Labour hours will be reimbursed at the facilities posted hourly labour rate.
- At Walinga's request, parts in question must be returned to the nearest Walinga service facility for evaluation. In such situations a Returned Goods Authorization (RGA) number will be provided to the buyer. The returning shipment must be clearly labeled with the assigned RGA number and include a copy of the RGA form. Unless otherwise arranged, these parts are to be returned to Walinga within 30 days to ensure timely processing of your warranty claim. Failure to return such parts may result in partial or complete loss of warranty coverage.
- Replacement parts provided under warranty are covered for the remainder of the original equipment warranty period.
- Walinga reserves the right to use new, remanufactured or refurbished components when performing warranty repairs and replacements.
- Walinga is entitled to a reasonable amount of time and a reasonable number of attempts to assess the claim, diagnose the problem, and perform any necessary repairs.
- The warranty offered on used or refurbished equipment is limited to that specified on the purchase contract. Where a warranty period has not been stipulated on the purchase contract., and where such equipment is "used", then such equipment is considered by Walinga to be sold "as is, where is" without the Walinga Warranty. Where such equipment is refurbished, then the Walinga Warranty shall apply.

Without limitation, Walinga reserves the right to reject a warranty claim or for any one or more of the following reasons:

- The warranty claim information provided is insufficient.
- The product evaluation does not substantiate the claim.
- The unit has been operated above and beyond its capacity or not maintained or serviced properly, resulting in damages incurred to major components.
- If the unit was equipped with a factory installed hour meter which has been disconnected, altered or inoperative for an extended period of time; with the result being that the equipment's operating hours cannot be verified.
- It is apparent that the operator's manuals have not been followed.
- The equipment is not registered.

Without limitation, Walinga's Warranty does not cover:

- Damage or deterioration due to lack of reasonable care or maintenance.
- Damage caused or affected by unapproved modifications to the equipment.
- Damage caused by negligence or misuse of the equipment.
- Damage caused by using the equipment for purposes for which it was not designed or intended.

Walinga's liability under this warranty, whether in contract or tort, is limited to the repair, replacement or adjustment of defective materials and workmanship. In no event will Walinga be responsible for any direct, indirect, loss of time, incidental or consequential expenses including, but not limited to, equipment rental expenses, towing, downtime, inconvenience, or any losses resulting from the inability to use the equipment. Further, Walinga shall not be liable for any damages or inconvenience caused by any delay in the supply or delivery of any equipment or component parts thereof.

The selling Dealer/Sales Person makes no warranty of its own and has no authority to make any representation or promise on behalf of Walinga, or to modify the terms or limitations of the Walinga Warranty in any way.

Punitive, exemplary or multiple damages may not be recovered unless applicable law prohibits their disclaimer.

Warranty related claims may not be brought forward as a class representative, a private attorney general, a member of a class of claimants or in any other representative capacity.

The Walinga Warranty and all questions regarding its enforceability and interpretation are governed by the law of the country, state or province in which you purchased your Walinga equipment. The laws of some jurisdictions limit or do not allow the disclaimer of consequential damages. If the laws of such a jurisdiction apply to any claim against Walinga, the limitations and disclaimers contained here shall be to the greatest extent permitted by law.

Dear Customer,

Thank you for choosing WALINGA PNEUMATIC CONVEYING SYSTEMS. For your convenience, should you require any information related to Parts, Service or Technical Engineering, please contact one of the following Walinga Personnel in Guelph at 1-888 925-4642 unless noted

TECHNICAL - ENGINEERING:

Duane Swaving 226-979-8227 duane.swaving@walinga.com

Ken Swaving 519 787-8227 (ext:100) ks@walinga.com

WARRANTY CLAIMS:

Canada: Gary Nijenhuis (ext:258) gary.nijenhuis@walinga.com

USA: Jonathan Medemblik (800) 466-1197 (ext 8) jtm@walinga.com

SERVICE MANAGER:

Andy Nijenhuis (519) 763-7000 (ext:260) andy@walinga.com

SALES MANAGER:

Canada: Tom Linde (519) 787-8227 (ext 5) thl@walinga.com

USA: Peter Kingma (800) 466-1197 jpk@walinga.com

ORIGINAL PARTS SALES:

Ontario and Eastern Canada:

Scott Lodder (ext: 224) spl@walinga.com

Parts Department Fax: (519) 824-0367

Manitoba and Western Canada:

Chad Yeo 204-745-2951 chad.yeo@walinga.com

USA: John VanMiddlekoop (800) 466-1197 (ext 3) jym@walinga.com

CORPORATE HEAD OFFICE:

5656 Highway 6N

RR#5, Guelph, Ontario, N1H 6J2

PHONE: (888) 925-4642 FAX: (519) 824-5651

www.walinga.com

AGRI-VAC MANUFACTURING FACILITY:

938 Glengarry Cres., Fergus, Ontario Canada N1M 2W7

Tel: (519) 787-8227 Fax: (519) 787-8210

DISTRIBUTION AND SERVICE CENTRES:

5656 Highway 6N, Guelph, Ontario Canada, N1H 6J2

Tel: (888) 925-4642 FAX: (519) 824-5651

1190 Electric Ave. Wayland , MI.USA 49348

Tel: (800) 466-1197 Fax: (616) 877-3474

70 3rd Ave. N.E. Box 1790 Carman, Manitoba Canada R0G 0J0

Tel: (204) 745-2951 Fax: (204) 745-6309

24 Molloy Street, Toowoomba, Queensland Australia 4350

Tel: 07-4634-7344 mail@customvac.com.au

SERIAL NUMBER LOCATION

Always give your dealer or Walinga the serial number of your Walinga Central Vacuum System when ordering parts or requesting service or other information. Serial number plates are located where indicated. Record serial numbers in the spaces provided.



Machine Serial Number

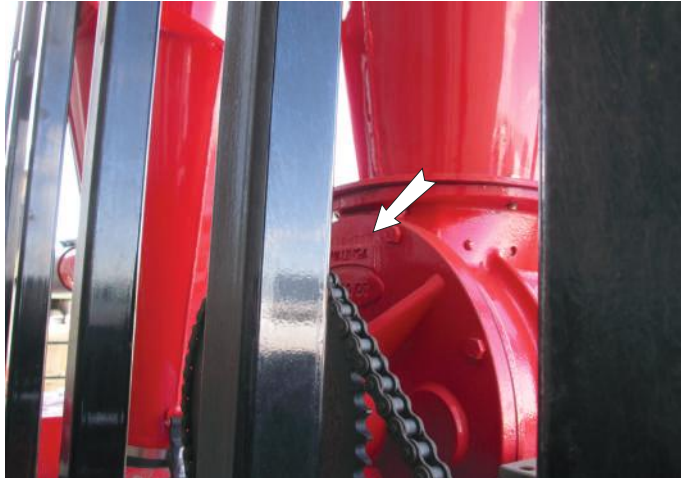

Airlock Serial Number



Blower Serial Number

Walinga Central-Vac Standard Operating Procedure (SOP)

NOTE: Read and understand the Operator's Manual and all safety signs before using the machine.

Start-Up

1. In the area that the vacuum work is to be performed, open the inlet by removing the plug.
2. Inspect the coupling seal and the condition of the hose, then plug the hose in. Make sure all the camlocks are correctly closed on the hose and the attached tools.

Please note: do not use the hose without a tool attached, as this may lead to premature wear and system plugging.

3. Make sure all the other inlets are closed.
4. Inspect the airlock discharge point for the following:
 - a. The airlock discharge spout is in place and sealed.
 - b. The dumpster or discharge point is free from obstruction.
 - c. The dumpster or discharge point has enough capacity for the work being performed. If the container is full, dump or replace the container.
 - d. The dumpster or discharge point will be secure under normal operating conditions.
5. Press the start button and confirm that the airlock is running.
6. Proceed to use the system.

Shutdown

1. Disconnect the hose from the inlet but do not install the inlet cap.
2. Clean up the hoses and the attachments, placing them on the hose and tool rack.
3. Press the stop button on the machine and wait for the airlock to stop.
4. Inspect the airlock discharge point and if the dumpster or discharge point is full, remove the material.
5. Close the inlet by placing the plug in the coupler, making sure that the camlocks are correctly closed.

Moving To A New Work Area

1. Stop conveying the product.
2. Disconnect the hose from the inlet.
3. Clean up all the hoses and tools.
4. Move to the new area.
5. In the new area, open the inlet by removing the plug.
6. Inspect the coupling seal and the hose condition, then plug the hose in. Make sure all the camlocks are correctly closed on the hose and the attached tools.
7. Close the inlet in the previous area.
8. Resume working in the new area.

Walinga Central-Vac Air-Purge SOP (Continued)

Daily Inspection

1. Inspect the filter and empty the filter canister into the dumpster or the discharge point.
2. Inspect the machine and the couplings for leaks.
3. Inspect the slide-gate (if equipped) and make sure that the slide-gate is operating correctly.
4. Inspect the airlock and the slide-gate discharge tubes making sure that they are free of obstructions.
5. Inspect the dumpster or discharge point. If they are full, dump or replace.

SOP For Light-Duty Or Dust Clean Up (2 inch hose only)

1. When cleaning up dust or performing other light duty tasks, two operators may use the system at the same time.
2. Make sure that no wet product is to be conveyed.
3. Use the 3 inch to 2 inch adapter to connect the 2 inch hose to the 3 inch inlet. Make sure there is a leak-free seal.
4. Follow the start-up procedure.
5. Use any 2 inch tool for light applications including but not limited to the crevice tool and the floor sweeps.
6. Submerging 2 inch tools with no air-slide into product for extended amounts of time will cause poor system performance and plugging
7. When task is complete, follow shutdown procedure.

SOP For Heavy Or Large Amounts Of Product (3 inch hose)

1. When cleaning up large amounts or heavy products only one operator may use the system.
2. Taking into account the amount of product being conveyed, make sure the dumpster or discharge point do not overflow.
3. Make sure no wet product is to be conveyed.
4. Use the 3 inch hose and connect it to the inlet.
5. Connect an attachment with an air-slide.
6. Follow start-up procedure.
7. Open the air-slide to the half position.
8. Insert the nozzle into the product and begin to convey the product.
9. Start to close the air-slide in 1/4" intervals until the product begins to pulsate in the line. At this point open the air-slide in 1/4 inch intervals until pulsating stops. Continue to adjust as required. In most situations, a 70% product with a 30% air-mixture is ideal.
10. If a plug occurs disconnect the hose from the inlet and allow the system to clear. Repeat from step 3 when the system is unplugged.
11. When task is complete, follow the shutdown procedure.

TABLE OF CONTENTS

SECTION	DESCRIPTION	PAGE
1	INTRODUCTION.....	1
2	SAFETY.....	3
2.1	GENERAL SAFETY	4
2.2	EQUIPMENT SAFETY GUIDELINES.....	5
2.3	STORAGE SAFETY	5
2.4	SAFETY TRAINING	6
2.5	SAFETY SIGNS.....	6
2.6	PREPARATION	7
2.7	INSTALLATION SAFETY	7
2.8	OPERATING SAFETY	8
2.9	MAINTENANCE SAFETY.....	8
2.10	ELECTRICAL SAFETY	9
2.11	LOCK-OUT TAG-OUT SAFETY	9
2.12	EMPLOYEE SIGN-OFF FORM.....	10
3	SAFETY SIGN LOCATIONS.....	11
4	OPERATION.....	19
4.1	TO THE NEW OPERATOR OR OWNER	19
4.2	MACHINE COMPONENTS.....	20
4.3	MACHINE BREAK-IN.....	21
4.4	PRE-OPERATION CHECKLIST.....	21
4.5	CONTROLS	22
4.6	OPERATION	24
4.7	STORAGE.....	36
5	SERVICE AND MAINTENANCE	37
5.1	SERVICE	37
5.2	MAINTENANCE.....	43
6	TROUBLE SHOOTING.....	55
7	SPECIFICATIONS	59
7.1	MECHANICAL.....	59
7.2	BOLT TORQUE	60
8	PARTS	61
9	INDEX.....	71

1 INTRODUCTION

Congratulations on your choice of a Walinga® Central Vacuum System to complement your manufacturing, food processing or feed milling operation. This equipment has been designed and manufactured to meet the needs of the discriminating buyer for the efficient moving of granular or powder products.

Safe, efficient and trouble free operation of your Central Vacuum System requires that you and anyone else who will be operating or maintaining the machine, read and understand the Safety, Operation, Maintenance and Trouble Shooting information contained within the Operator's Manual.



This manual covers all Central Vacuum Systems made by Walinga® Inc. Many systems are custom designed for the specific application. However they are all similar and specific differences are explained where appropriate.

Keep this manual handy for frequent reference and to pass on to new operators or owners. Call your Walinga® dealer if you need assistance, information or additional copies of the manual. Contact your dealer for a complete listing of parts.

2 SAFETY

SAFETY ALERT SYMBOL

This Safety Alert symbol means
**ATTENTION! BECOME ALERT! YOUR
SAFETY IS INVOLVED!**



The Safety Alert symbol identifies important safety messages on the Walinga® Central Vacuum System and in the manual. When you see this symbol, be alert to the possibility of personal injury or death. Follow the instructions in the safety message.

Why is SAFETY important to you?

3 Big Reasons

Accidents Disable and Kill
Accidents Cost
Accidents Can Be Avoided

SIGNAL WORDS:

Note the use of the signal words **DANGER**, **WARNING** and **CAUTION** with the safety messages. The appropriate signal word for each message has been selected using the following guide-lines:

DANGER - Indicates an imminently hazardous situation that, if not avoided, will result in death or serious injury. This signal word is to be limited to the most extreme situations typically for machine components which, for functional purposes, cannot be guarded.

WARNING - Indicates a potentially hazardous situation that, if not avoided, could result in death or serious injury, and includes hazards that are exposed when guards are removed. It may also be used to alert against unsafe practices.

CAUTION - Indicates a potentially hazardous situation that, if not avoided, may result in minor or moderate injury. It may also be used to alert against unsafe practices.

Keep this manual handy for frequent reference and to pass on to new operators or owners. Call your Walinga® dealer if you need assistance, information or additional copies of the manual. Contact your dealer for a complete listing of parts.





SAFETY

YOU are responsible for the **SAFE** operation and maintenance of your Walinga® Central Vacuum System. **YOU** must ensure that you and anyone else who is going to operate, maintain or work around the Central Vacuum System be familiar with the operating and maintenance procedures and related **SAFETY** information contained in this manual. This manual will take you step-by-step through your working day and alerts you to all good safety practices while operating the Central Vacuum System.

Remember, **YOU** are the key to safety. Good safety practices not only protect you but, also the people around you. Make these practices a working part of your safety program. Be certain that **EVERYONE** operating this machine is familiar with the procedures recommended and follows safety precautions. Remember, most accidents can be prevented. Do not risk injury or death by ignoring good safety practices.

- Central Vacuum System owners must give operating instructions to operators or employees before allowing them to operate the machine, and at least annually thereafter.
- The most important safety device on this equipment is a SAFE operator. It is the operator's responsibility to read and understand ALL Safety and Operating instructions in the manual and to follow these. Most accidents can be avoided.
- A person who has not read and understood all operating and safety instructions is not qualified to operate this machine. An untrained operator exposes himself and bystanders to possible serious injury or death.
- Do not modify the equipment in any way. Unauthorized modification may impair the function and/or safety and could affect the life of the equipment.
- Think SAFETY! Work SAFELY!

2.1 GENERAL SAFETY

1. Read and understand the Operator's Manual and all safety signs before supplying power, operating, maintaining , adjusting or unplugging. 
2. Only trained, competent persons shall operate the Central Vacuum System. An untrained operator is not qualified to operate this machine.
3. Provide a first-aid kit for use in case of an accident. Store in a highly visible place. 
4. Provide a fire extinguisher for use in case of an accident. Store in a highly visible place. 
5. Install and properly secure all guards and shields before operating.
6. Wear appropriate protective gear. This list includes but is not limited to:
 - A hard hat
 - Protective shoes with slip resistant soles
 - Protective glasses or goggles
 - Heavy gloves
 - Wet weather gear
 - Hearing protection
7. Turn machine OFF, shut down and lockout power supply and wait for all moving parts to stop before servicing, adjusting, maintaining, repairing, cleaning or unplugging. (Safety lockout devices are available through your Walinga® dealer parts department).
8. Know the emergency medical center number for your area.
9. Wear appropriate hearing protection when operating the machine. 
10. Ground all lines, hoses and wands to prevent static build-up and electrical discharge/shocks.
11. Review safety related items with all operators annually.

2.2 EQUIPMENT SAFETY GUIDELINES

1. Safety of the operator and bystanders is one of the main concerns in designing and developing a machine. However, every year many accidents occur which could have been avoided by a few seconds of thought and a more careful approach to handling equipment. You, the operator, can avoid many accidents by observing the following precautions in this section. To avoid personal injury or death, study the following precautions and insist those working with you, or for you, follow them.
2. In order to provide a better view, certain photographs or illustrations in this manual may show an assembly with a safety shield removed. However, equipment should never be operated in this condition. Keep all shields in place. If shield removal becomes necessary for repairs, replace the shield prior to use.
3. Replace any safety sign or instruction sign that is not readable or is missing. Location of such safety signs is indicated in this manual.
4. Never use alcoholic beverages or drugs which can hinder alertness or coordination while operating this equipment. Consult your doctor about operating this machine while taking prescription medications.
5. **Under no circumstances should young children be allowed to work with this equipment. Do not allow persons to operate or assemble this unit until they have read this manual and have developed a thorough understanding of the safety precautions and of how it works.** Review the safety instructions with all users annually.
6. This equipment is dangerous to children and persons unfamiliar with its operation. The operator should be a responsible, properly trained and physically able person familiar with farm machinery and trained in this equipment's operations. If the elderly are assisting with farm work, their physical limitations need to be recognized and accommodated.
7. Never exceed the limits of a piece of machinery. If its ability to do a job, or to do so safely, is in question - **DON'T TRY IT.**
8. Do not modify the equipment in any way. Unauthorized modification may result in serious injury or death and may impair the function and life of the equipment.

9. In addition to the design and configuration of this implement, including Safety Signs and Safety Equipment, hazard control and accident prevention are dependent upon the awareness, concern, prudence, and proper training of personnel involved in the operation, transport, maintenance, and storage of the machine. Refer also to Safety Messages and operation instruction in each of the appropriate sections of the auxiliary equipment and machine Manuals. Pay close attention to the Safety Signs affixed to the auxiliary equipment and the machine.

2.3 STORAGE SAFETY

1. Store the Central Vacuum System on a firm level surface.
2. If required, make sure the unit is firmly blocked up.
3. Make certain that all mechanical locks are safely and positively connected before storing.
4. Store away from areas of human activity.
5. Do not allow children to play on or around the stored Central Vacuum System.
6. Lock out power by turning off master control panel or junction box and padlocking the door shut to prevent electrocution or unauthorized start up of the Central Vacuum System.

2.4 SAFETY TRAINING

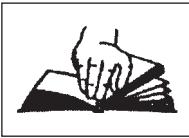
1. Safety is a primary concern in the design and manufacture of our products. Unfortunately, our efforts to provide safe equipment can be wiped out by a single careless act of an operator or bystander.
2. In addition to the design and configuration of equipment, hazard control and accident prevention are dependent upon the awareness, concern, prudence and proper training of personnel involved in the operation, transport, maintenance and storage of this equipment.
3. It has been said, "The best safety feature is an informed, careful operator." We ask you to be that kind of an operator. It is the operator's responsibility to read and understand ALL Safety and Operating instructions in the manual and to follow these. Accidents can be avoided.

4. **Working with unfamiliar equipment can lead to careless injuries. Read this manual, and the manual for your auxiliary equipment, before assembly or operating, to acquaint yourself with the machines. If this machine is used by any person other than yourself. It is the machine owner's responsibility to make certain that the operator, prior to operating:**
 - a. **Reads and understands the operator's manuals.**
 - b. **Is instructed in safe and proper use.**
5. Know your controls and how to stop the Central Vacuum System and any other auxiliary equipment quickly in an emergency. Read this manual and the one provided with your other equipment.
6. Train all new personnel and review instructions frequently with existing workers. Be certain only a properly trained and physically able person will operate the machinery. A person who has not read and understood all operating and safety instructions is not qualified to operate the machine. An untrained operator exposes himself and bystanders to possible serious injury or death. If the elderly are assisting with work, their physical limitations need to be recognized and accommodated.

2.5 SAFETY SIGNS

1. Keep safety signs clean and legible at all times.
2. Replace safety signs that are missing or have become illegible.
3. Replaced parts that displayed a safety sign should also display the current sign.
4. Safety signs are available from your authorized Distributor or Dealer Parts Department or the factory.

How to Install Safety Signs:

- Be sure that the installation area is clean and dry.
- Be sure temperature is above 50°F (10°C).
- Determine exact position before you remove the backing paper. (See Section 3).
- Remove the smallest portion of the split backing paper.
- Align the sign over the specified area and carefully press the small portion with the exposed sticky backing in place.
- Slowly peel back the remaining paper and carefully smooth the remaining portion of the sign in place.
- Small air pockets can be pierced with a pin and smoothed out using the piece of sign backing paper.

How to Reorder Your Safety Signs:

1. Call you local dealer, or the factory branch nearest you.

FACTORY DISTRIBUTION AND SERVICE CENTRES:

Head Office:

RR#5, Guelph, Ontario, N1H 6J2

PHONE (888) 925-4642

FAX (519) 824-5651

938 Glengarry Cres. Fergus, Ontario Canada N1M 2W7
Tel: (519) 787-8227 Fax: (519) 787-8210

70 3rd Ave. N.E. Box 1790 Carman, Manitoba
Canada R0G 0J0
Tel (204) 745-2951 Fax (204) 745-6309

1190 Electric Ave. Wayland, MI. USA 49348
Tel (800) 466-1197 Fax (616) 877-3474

2.6 PREPARATION

1. Never operate the Central Vacuum System and auxiliary equipment until you have read and completely understand this manual, the auxiliary equipment Operator's Manual, and each of the Safety Messages found on the safety signs on the and auxiliary equipment.

2. Personal protection equipment including hard hat, safety glasses, safety shoes, and gloves are recommended during assembly, installation, operation, adjustment, maintaining, repairing, removal, or moving the implement. Do not allow long hair, loose fitting clothing or jewelery to be around equipment.



3. **PROLONGED EXPOSURE TO LOUD NOISE MAY CAUSE PERMANENT HEARING LOSS!**

Motors or equipment attached can often be noisy enough to cause permanent, partial hearing loss. We recommend that you wear hearing protection on a full-time basis if the noise in the Operator's position exceeds 80db. Noise over 85db on a long-term basis can cause severe hearing loss. Noise over 90db adjacent to the Operator over a long-term basis may cause permanent, total hearing loss. **NOTE:** Hearing loss from loud noise (from tractors, chain saws, radios, and other such sources close to the ear) is cumulative over a lifetime without hope of natural recovery.



4. Clear working area of debris, trash or hidden obstacles that might be hooked or snagged, causing injury, damage or tripping.
5. Operate only in daylight or good artificial light.
6. Be sure machine is properly anchored, adjusted and in good operating condition.
7. Ensure that all safety shielding and safety signs are properly installed and in good condition.
8. Before starting, give the machine a "once over" for any loose bolts, worn parts, cracks, leaks, frayed belts and make necessary repairs. Always follow maintenance instructions.

2.7 INSTALLATION SAFETY

1. Disconnect and remove all mechanical locks, anchor chains and any other transport devices that would hinder or prohibit the normal functioning of the Central Vacuum System upon start up. Serious damage to the machine and/or personal injury to the operator and bystanders may result from attempting to operate the machine while mechanical locking devices are still attached.
2. Anchor the machine to firm, level ground before operating.
3. Level the frame before using or loading.
4. Have at least one extra person available to assist when elevating, moving or connecting to other equipment.
5. Make certain that sufficient amperage, at the proper voltage and frequency (60Hz) is available before connecting power for the electric model. Have a licensed electrician provide power to the machine. Always follow ANSI/NFPA 70 Standard and all local codes when providing electrical power.
6. If using Central Vacuum System as part of material handling system, anchor securely before starting.
7. Vent discharge air from blower to outside.
8. Maintain 18" maximum Machine Distance from the wall.
9. Walinga would like to remind the owner of this piece of equipment, that in order to be in accordance with NFPA 652-Chapter 7, a Dust Hazards Analysis (DHA) must be completed.

2.8 OPERATING SAFETY

1. Read and understand the Operator's Manual and all safety signs before operating, maintaining, adjusting or repairing the Central Vacuum System.
2. Before servicing, adjusting, repairing or maintaining unit, ensure that unit power source is completely shut down and can not start up.
3. Do not operate when any guards are damaged or removed, Install and secure guards before starting.
4. Keep hands, feet, clothing and hair away from all moving and/or rotating parts.
5. Clear the area of all bystanders, especially small children, before starting.
6. Before supplying electrical power to the machine, be sure you have adequate amperage at the proper phase and voltage to run it. If you do not know or are unsure, consult a licensed electrician.
7. Wear appropriate ear protection when operating machine.
8. Do not place intake nozzle near feet when standing on the top of grain.

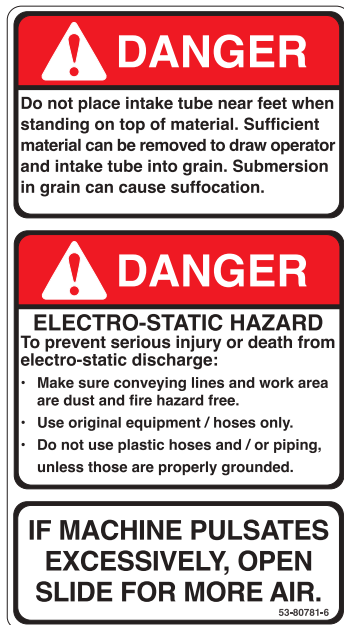

9. Review safety instructions with all personnel annually.

2.9 MAINTENANCE SAFETY

1. Good maintenance is your responsibility. Poor maintenance is an invitation to trouble. Follow all operating, maintenance and operating instructions in this manual.
2. Support the machine with blocks of safety stands when working beneath it.
3. Follow good shop practices:
 - Keep service area clean and dry.
 - Be sure electrical outlets and tools are properly grounded.
 - Use adequate light for the job at hand.

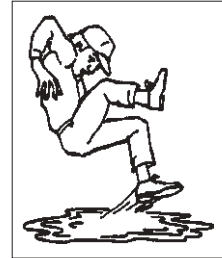

4. Use only tools, jacks or hoists of sufficient capacity for the job.
5. Before servicing, adjusting, repairing or maintaining unit, ensure that power source is completely shut down and locked-out, tagged-out.
6. Always use personal protection devices such as eye, hand and hearing protectors, when performing any service or maintenance work.
7. A fire extinguisher and first aid kit should be kept readily accessible while performing maintenance on this equipment.



8. Make sure all guards are in place and properly secured when maintenance work is completed.
9. Keep hands, feet, hair and clothing away from all moving and/or rotating parts.
10. Lock-out, tag-out master panel before performing any maintenance work on machine or opening air-lock access door.
11. Clear the area of bystanders, especially small children, when carrying out any maintenance and/or repairs or making any adjustments.
12. Be sure all lines, hoses and wands are grounded when maintenance work is completed.

2.10 ELECTRICAL SAFETY

1. Have only a qualified licensed electrician supply power to the electric model by following ANSI/NFPA 70 Wiring Standard. Make certain that the Central Vacuum System is properly grounded at the power source.
2. Install safety decals on Master Control panel as per Section 3 - Safety Sign Locations (pg 17)/
3. Make certain that all electrical switches are in the OFF position before plugging the Central Vacuum System in.
4. Turn machine OFF, shut down and lock out power supply (safety lockout devices are available through your Walinga® dealer parts department) and wait for all moving parts to stop before servicing, adjusting, maintaining or repairing.
5. Disconnect power before resetting any motor or breaker overload.
6. Replace any damaged electrical plugs, cords, switches and components immediately.
7. Do not work on Central Vacuum System electrical system unless the power cord is unplugged or the power supply is locked-out tagged-out.
8. Check continuity of all couplings.



2.11 LOCK-OUT TAG-OUT SAFETY

1. Establish a formal Lock-Out Tag-Out program for your operation.
2. Train all operators and service personnel before allowing them to work around the Central Vacuum System.
3. Provide tags at the work site and a sign-up sheet to record tag out details.
4. Do not perform any service or maintenance work unless motor is OFF and the power locked out.

3 SAFETY SIGN LOCATIONS

The types of safety signs and locations on the equipment are shown in the illustrations that follow. Good safety requires that you familiarize yourself with the various Safety Signs, the type of warning and the area, or particular function related to that area, that requires your SAFETY AWARENESS.

- Think SAFETY! Work SAFELY!



A

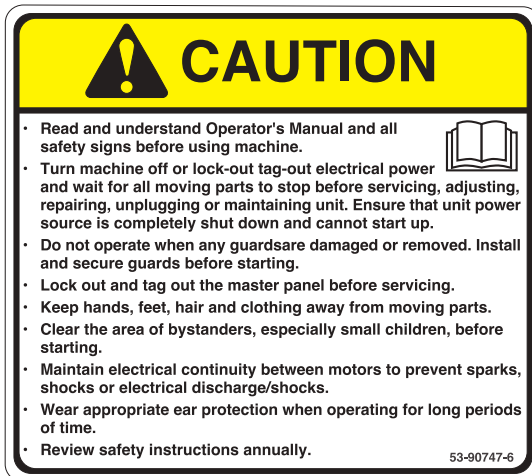

B



REMEMBER - If Safety Signs have been damaged, removed, become illegible or parts replaced without safety signs, new signs must be applied. New safety signs are available from your authorized dealer.

The types of safety signs and locations on the equipment are shown in the illustrations that follow. Good safety requires that you familiarize yourself with the various Safety Signs, the type of warning and the area, or particular function related to that area, that requires your SAFETY AWARENESS.

- Think SAFETY! Work SAFELY!



REMEMBER - If Safety Signs have been damaged, removed, become illegible or parts replaced without safety signs, new signs must be applied. New safety signs are available from your authorized dealer.

The types of safety signs and locations on the equipment are shown in the illustrations that follow. Good safety requires that you familiarize yourself with the various Safety Signs, the type of warning and the area, or particular function related to that area, that requires your SAFETY AWARENESS.

- Think SAFETY! Work SAFELY!

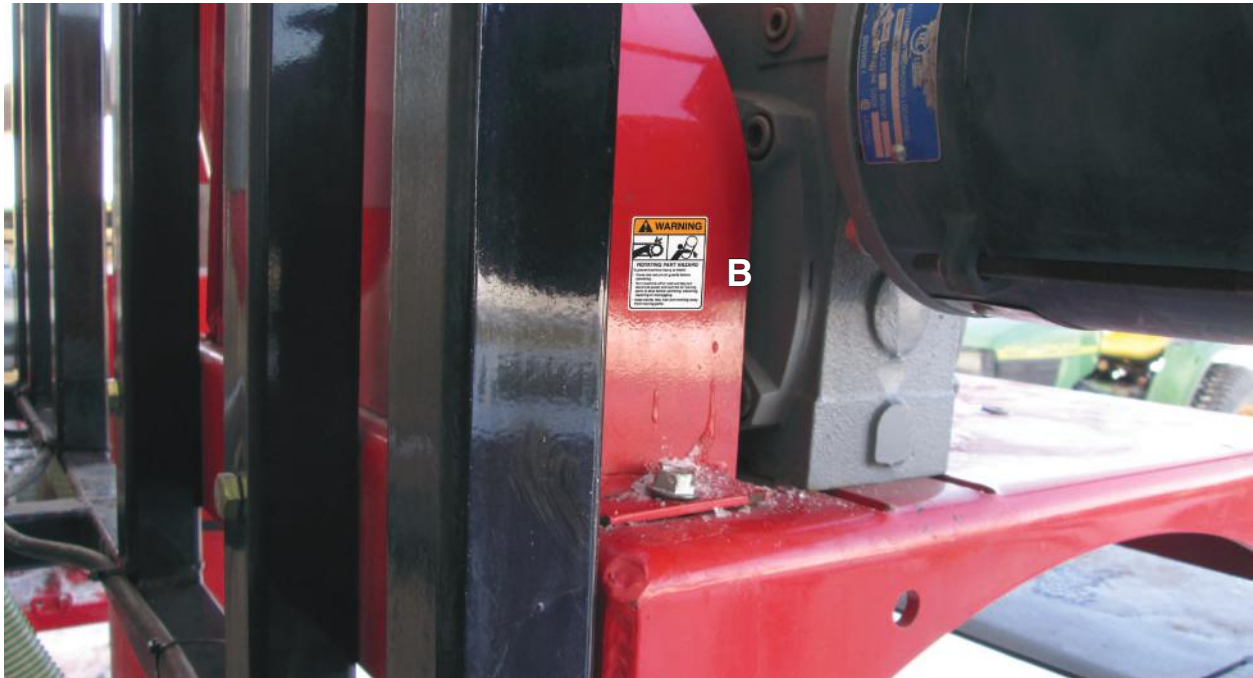

REMEMBER - If Safety Signs have been damaged, removed, become illegible or parts replaced without safety signs, new signs must be applied. New safety signs are available from your authorized dealer.

The types of safety signs and locations on the equipment are shown in the illustrations that follow. Good safety requires that you familiarize yourself with the various Safety Signs, the type of warning and the area, or particular function related to that area, that requires your SAFETY AWARENESS.

- Think SAFETY! Work SAFELY!

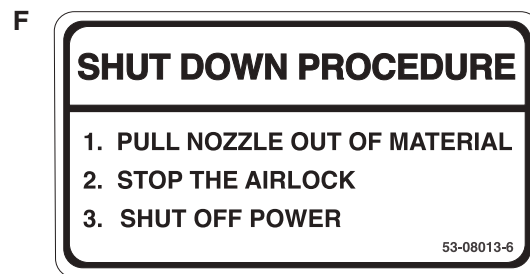
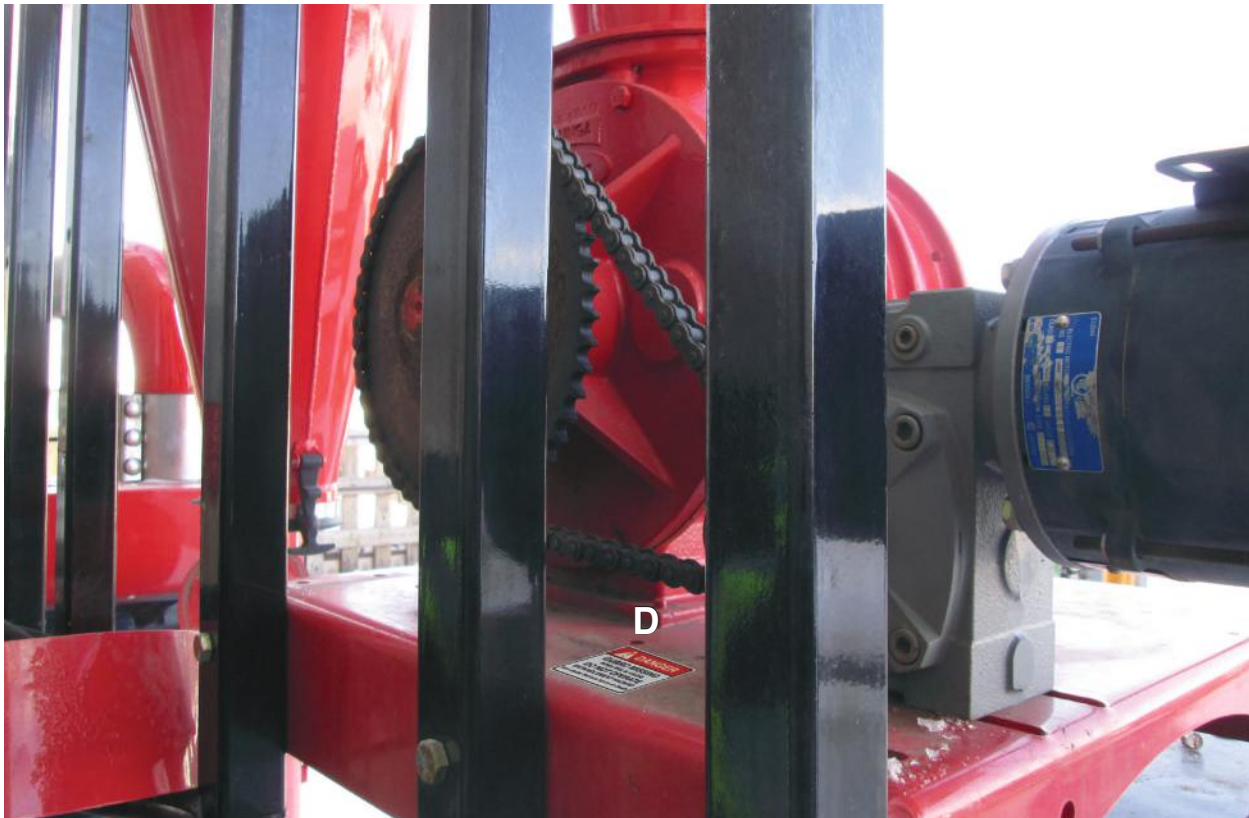

REMEMBER - If Safety Signs have been damaged, removed, become illegible or parts replaced without safety signs, new signs must be applied. New safety signs are available from your authorized dealer.

The types of safety signs and locations on the equipment are shown in the illustrations that follow. Good safety requires that you familiarize yourself with the various Safety Signs, the type of warning and the area, or particular function related to that area, that requires your SAFETY AWARENESS.

- Think SAFETY! Work SAFELY!

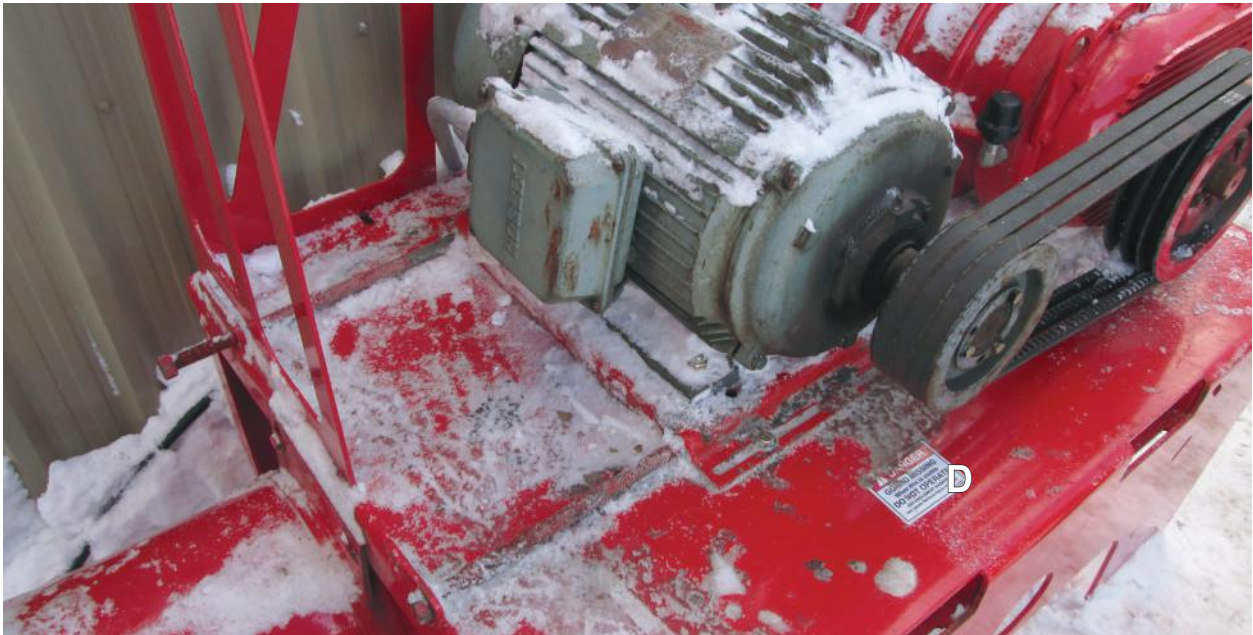

G

 **DANGER**

Do not place intake tube near feet when standing on top of material. Sufficient material can be removed to draw operator and intake tube into grain. Submersion in grain can cause suffocation.

 **DANGER**

ELECTRO-STATIC HAZARD
To prevent serious injury or death from electro-static discharge:

- Make sure conveying lines and work area are dust and fire hazard free.
- Use original equipment / hoses only.
- Do not use plastic hoses and / or piping, unless those are properly grounded.

IF MACHINE PULSATES EXCESSIVELY, OPEN SLIDE FOR MORE AIR.

53-80781-6

H

 **DANGER**



Turn machine OFF, shut down and lock out electrical power source and wait 30 seconds for all moving parts to stop before servicing, repairing electrical components or opening control panel door to prevent electrocution.

53-18288-6

REMEMBER - If Safety Signs have been damaged, removed, become illegible or parts replaced without safety signs, new signs must be applied. New safety signs are available from your authorized dealer.

The types of safety signs and locations on the equipment are shown in the illustrations that follow. Good safety requires that you familiarize yourself with the various Safety Signs, the type of warning and the area, or particular function related to that area, that requires your SAFETY AWARENESS.

- Think SAFETY! Work SAFELY!

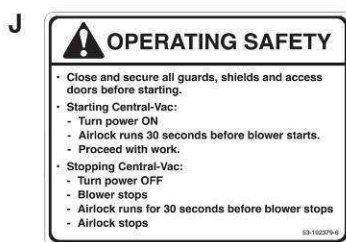

REMEMBER - If Safety Signs have been damaged, removed, become illegible or parts replaced without safety signs, new signs must be applied. New safety signs are available from your authorized dealer.

The types of safety signs and locations on the equipment are shown in the illustrations that follow. Good safety requires that you familiarize yourself with the various Safety Signs, the type of warning and the area, or particular function related to that area, that requires your SAFETY AWARENESS.

- Think SAFETY! Work SAFELY!



REMEMBER - If Safety Signs have been damaged, removed, become illegible or parts replaced without safety signs, new signs must be applied. New safety signs are available from your authorized dealer.

The types of safety signs and locations on the equipment are shown in the illustrations that follow. Good safety requires that you familiarize yourself with the various Safety Signs, the type of warning and the area, or particular function related to that area, that requires your SAFETY AWARENESS.

- Think SAFETY! Work SAFELY!



REMEMBER - If Safety Signs have been damaged, removed, become illegible or parts replaced without safety signs, new signs must be applied. New safety signs are available from your authorized dealer.

4 OPERATION



OPERATING SAFETY

- Read and understand the Operator's Manual and all safety signs before operating, maintaining, adjusting or repairing the Central Vacuum System.
- Before servicing, adjusting, repairing or maintaining unit, ensure that unit power source is completely shut down and can not start up.
- Establish a Lock-Out Tag-Out program for the worksite.
- Do not operate when any guards are damaged or removed, Install and secure guards before starting.
- Keep hands, feet, clothing and hair away from all moving and/or rotating parts.
- Lock-out tag-out master panel before opening airlock door.
- Clear the area of all bystanders, especially small children, before starting.
- Before supplying electrical power to the machine, be sure you have adequate amperage at the proper phase and voltage to run it. If you do not know or are unsure, consult a licensed electrician.
- Be sure all personnel know the airlock runs 30 seconds before blower starts and 30 seconds after blower stops.
- Ground all lines, hoses and wands to prevent static build-up and electrical discharge.
- Maintain electrical continuity between material intake and airlock/blower to prevent sparks, shocks or electrical discharges.
- Wear appropriate ear protection when operating machine.
- Do not place intake nozzle near feet when standing on the top of material.
- Review safety instructions annually.

4.1 TO THE NEW OPERATOR OR OWNER

The Walinga® Central Vacuum System is designed to vacuum up grain, powder or other granular material and move it in a stream of pressurized air. A high capacity air pump moves the air through the machine creating a vacuum on the intake side and pressure on the outlet side. Be familiar with all operating and safety procedures before starting.

In addition to the design and configuration of equipment, hazard control and accident prevention are dependent upon the awareness, concern, prudence and proper training of personnel involved in the operation, transport, maintenance and storage of this equipment.

It is the responsibility of the owner or operator to read this manual and to train all other operators before they start working with the machine. Follow all safety instructions exactly. Safety is everyone's business. By following recommended procedures, a safe working environment is provided for the operator, bystanders and the area around the worksite. Untrained operators are not qualified to operate the machine.

Many features incorporated into this machine are the result of suggestions made by customers like you. Read this manual carefully to learn how to operate the machine safely and how to set it to provide maximum efficiency. By following the operating instructions in conjunction with a good maintenance program, your Central Vacuum System will provide many years of trouble-free service.

4.2 MACHINE COMPONENTS

The machine is designed with an air pump or blower drawing air and material into the intake wands, hose and piping. An electric motor powers the blower through a set of belts. A large filter on the intake side removes dust from the air intake before it enters the blower.

Seed, powder or other loose granular material is drawn into the system through the wands and hose/pipes. Material drops out of the air stream when it enters the cyclone. From the receiver cyclone, the material drops into the turning airlock that discharges it from the system.

- | | | | |
|----------|--------------------------|----------|----------------------------|
| A | Electric Motor | K | Intake Wand |
| B | Belt Drive Cover | L | Pick-up Point |
| C | Blower | M | Flapper Valve |
| D | Intake Filter | N | Self Dumping Bin |
| E | Air Lines | O | Reducing Coupler |
| F | Collector Cyclone | P | Crevice Tool |
| G | Air Lock | R | Controls |
| H | Chain Drive Cover | S | Vacuum Relief Valve |
| J | Intake Hose | | |



FIG. 1 MACHINE COMPONENTS

4.3 MACHINE BREAK-IN

Although there are no operational restrictions on the Central Vacuum System when used for the first time, it is recommended that the following mechanical items be checked:

A. After operating for 1/2 hour:

1. Retorque all fasteners and hardware.
2. Turn blower and airlock by hand. Be sure that they turn freely.
3. Open and clean the pre-cleaner door, filter and tank.
4. Check that no hoses are pinched, rubbing or being crimped. Re-align as required.
5. Check oil level in reservoirs. Add as required.
6. Lubricate all grease fittings.

B. After operating for 5 hours and 10 hours:

1. Retorque all bolts, fasteners and hardware.
2. Check hose routing.
3. Check that blower and airlock turn freely.
4. Check oil level in reservoirs.
5. Then go to the normal servicing and maintenance schedule as defined in the Maintenance Section.

4.4 PRE-OPERATION CHECKLIST

Efficient and safe operation of the Walinga® Central Vacuum System requires that each operator reads and understands the operating procedures and all related safety precautions outlined in this section. A pre-operation checklist is provided for the operator. It is important for both the personal safety and maintaining the good mechanical condition of the Central Vacuum that this checklist is followed.

Before operating the Vacuum and each time thereafter, the following areas should be checked off:

1. Lubricate the machine per the schedule outlined in Section 5 Service and Maintenance.
2. Check the oil level in the blower reservoirs.
3. Inspect all air lines, hoses, fittings and cam lock couplers for sealing and tightness.
4. Open intake filter cannister, remove coarse material from assembly and clean filter.
5. Open flapper door on the bottom of secondary cyclone and empty compartment. Close and secure flapper.
6. Check that the blower and airlock turn freely.
7. Check for and remove entangled material.
8. Close and secure all guards.

4.5 CONTROLS

Each customer is responsible to provide the appropriate control panel and power supply to the machine. It is recommended that the customer have a licensed electrician provide power per ANSI/NFPA 70 Standard and all applicable local codes when providing power to the motor.

The Central Vacuum System can be wired into a large control room away from the machine or controlled by the control boxes next to the unit.

Be familiar with the specific control box system before starting.

1. Master Control Panel:

- a. **Start:**
This green two-position push-button switch is used to turn power ON to the control panel. Depress the switch to turn power ON. When power is on, the switch will illuminate.
- b. **Stop:**
This red two-position push-button switch is used to turn the power OFF to the control panel. Depress the switch to turn power OFF. When the red switch is depressed the green start switch light will go off.
- c. **Airlock:**
This light is illuminated when the airlock is running and goes out when it stops.

IMPORTANT

The airlock is designed to run for approximately 30 seconds before the blower turns ON and will continue for 30 seconds after the blower shuts down. This insures the collecting cyclone is empty before introducing more material into the system.

- d. **Blower:**
This light is illuminated when blower is running and goes out when it stops.
- e. **Reset (Blower - Left):**
This lighted switch monitors the status of the blower circuit breaker inside the panel. For normal operation, the light is OFF. If the blower circuit becomes overloaded, the circuit breaker will trip and the switch will be illuminated. Correct the problem and depress the switch to reset the breaker.

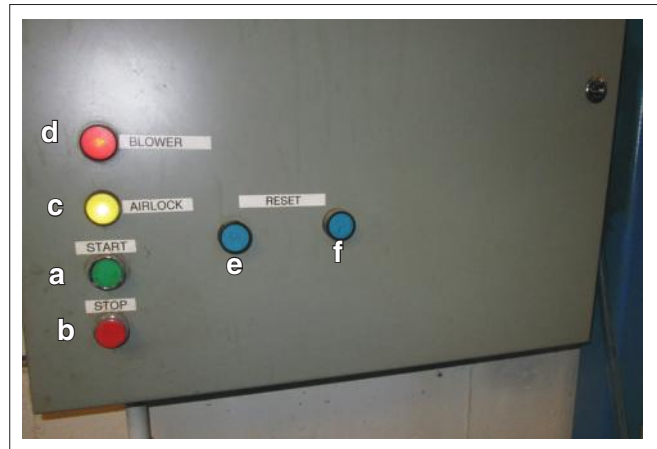

FIG. 2 MASTER CONTROL PANEL

- f. **Reset (Airlock - Right):**
This lighted switch monitors the status of the airlock circuit breaker inside the panel. For normal operation, the light is OFF. If the airlock circuit becomes overloaded, the circuit breaker will trip and the switch will be illuminated. Correct the problem and depress the switch to reset the breaker.

2. **Power Disconnects:**

The system is designed with switches close to the machine that allow the operator to disconnect the power to the respective motors as required. Turn the switch into its vertical configuration to provide power to the motor and horizontal to disconnect power.

- a. **Airlock**
- b. **Blower**

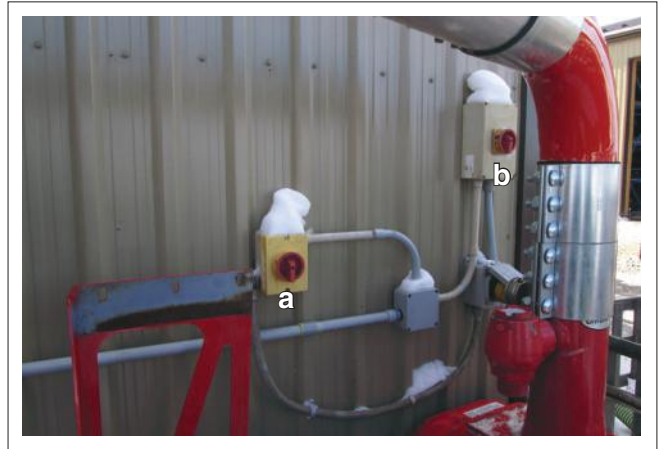

FIG. 3 POWER DISCONNECTS

4.6 OPERATION



OPERATING SAFETY

- Read and understand the Operator's Manual and all safety signs before operating, maintaining, adjusting or repairing the Central Vacuum System.
- Before servicing, adjusting, repairing or maintaining unit, ensure that unit power source is completely shut down and can not start up.
- Establish a Lock-Out Tag-Out program for the worksite.
- Do not operate when any guards are damaged or removed, Install and secure guards before starting.
- Keep hands, feet, clothing and hair away from all moving and/or rotating parts.
- Lock-out tag-out master panel before opening airlock door.
- Clear the area of all bystanders, especially small children, before starting.
- Before supplying electrical power to the machine, be sure you have adequate amperage at the proper phase and voltage to run it. If you do not know or are unsure, consult a licensed electrician.
- Be sure all personnel know the airlock runs 30 seconds before blower starts and 30 seconds after blower stops.
- Ground all lines, hoses and wands to prevent static build-up and electrical discharge.
- Maintain electrical continuity between material intake and airlock/blower to prevent sparks, shocks or electrical discharges.
- Wear appropriate ear protection when operating machine.
- Do not place intake nozzle near feet when standing on the top of material.
- Review safety instructions annually.

The Walinga® Central Vacuum System is used to pick up and move grain, powder or other granular material from one location to another on a stream of air. Before starting, the operator has the responsibility of being familiar with all operating and safety procedures and following them.

Each operator should review this section of the manual at the start of the season and as often as required to be familiar with the Central Vacuum System. When operating the machine, follow this procedure:

1. Clear the area of bystanders, especially small children before starting.
2. Review and follow the pre-operation checklist (See Section 4.4).
3. Attach the components required to pick up the dust or granular material as appropriate for your application.
 - a. Check the integrity of the coupler gasket seal.

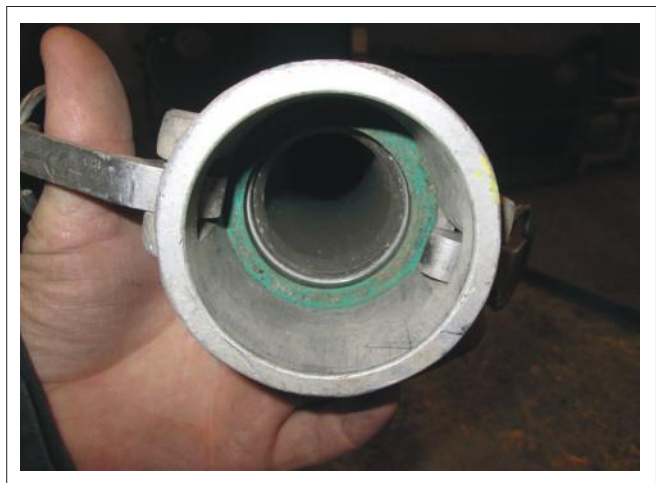

FIG. 4 GASKET SEAL

- b. Attach hose to Cam Lock Coupler.



FIG. 5 CAM LOCK COUPLER

- c. Attach gathering component to the end of the hose.

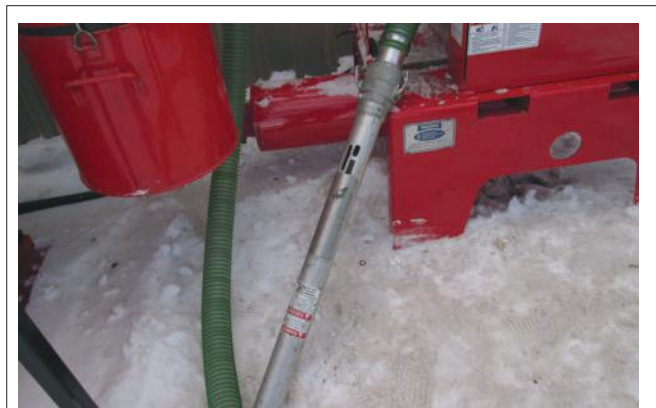

Intake Tube



Crevice Tool



Wand

FIG. 6 GATHERING COMPONENTS (TYPICAL)

4. Position Hopper Bin under airlock discharge.



FIG. 7 HOPPER BIN

5. **Starting Machine:**

- a. Check that the master panel is not locked out. If it is, identify cause and retrieve the tag. Turn master panel on.
- b. Turn power disconnects switches ON.



Power Disconnects

- c. Turn power ON at the master control panel.

IMPORTANT

When machine is turned on, the airlock will start and run 30 seconds before the blower will start.



Master Control Panel

FIG. 8 SWITCHES (TYPICAL)

6. **Stopping Machine:**

Turn the machine off using the STOP switch. This will shut down both the blower and the airlock but the airlock will run 30 seconds after the blower stops.

IMPORTANT

When machine is turned off, the airlock will run 30 seconds after the blower stops.

7. **Gathering Material:**

- a. Use the open end of the tube, nozzle or wands to pick up material.
- b. Several types of tubes or wands are available to use. The operator can select the one most appropriate for their application.



Wand



Straight Nozzle



Crevice Tool

FIG. 9 GATHERING MATERIAL

8. **Air Slide:**

Each wand is designed with an air slide on the tube that can be used to control the amount of air entering the machine along with gathered material. Always move the wand so that sufficient air enters the system to move the material and cool the blower. Do not starve the system for air.

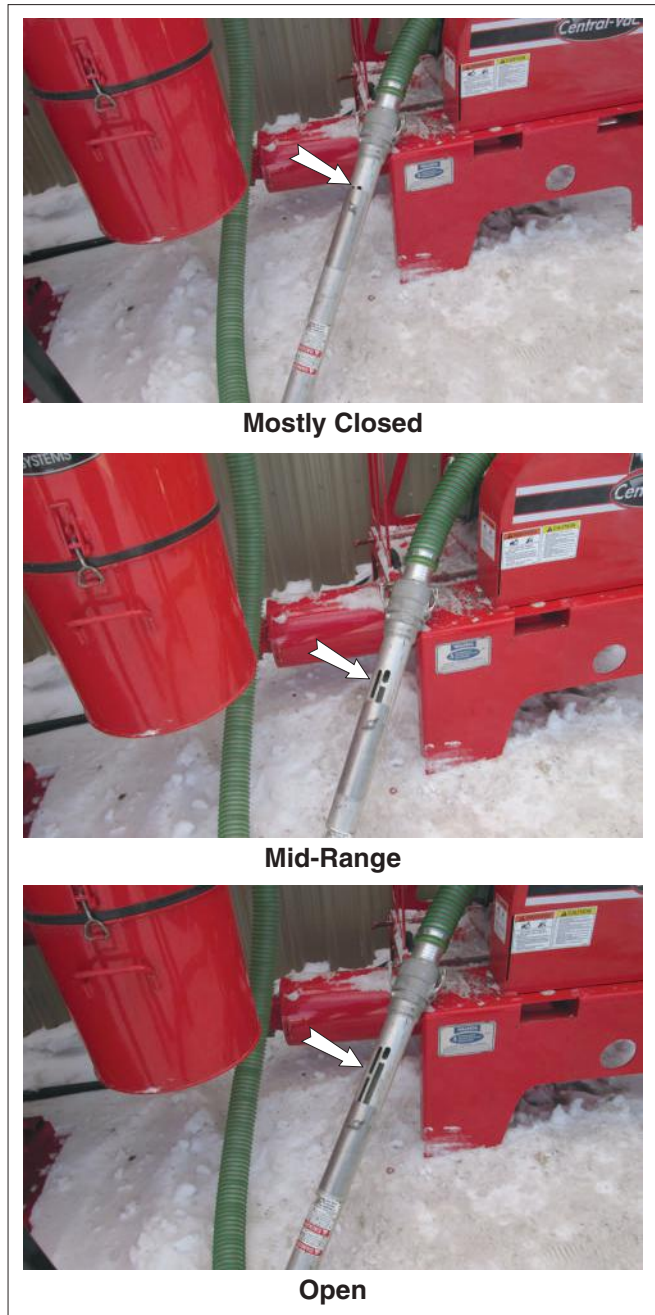



FIG. 10 AIR SLIDE (TYPICAL)

 **DANGER**

Do not place intake tube near feet when standing on top of material. Sufficient material can be removed to draw operator and intake tube into material. Submersion in material can cause suffocation.

10. **Nozzle Position:**

Do not place the nozzle between your feet when picking up a deep pile of granular material. The nozzle can pick up sufficient material to draw the operator into the pile and suffocate them. Always pick up material away from nozzle.

11. System Grounding:

- a. Granular material flowing through pipes, hoses or lines can generate an electrical charge that will create electrical discharges, static and/or sparks. In high dust environments sparks or electrical discharges can set off an explosion. This static charge condition can be very annoying to an operator.

The system is designed using steel lines, metal arm lock couplers on all fittings, a metal spiral strand in the hose that is attached to each fitting and metal pick-up components to maintain electrical ground continuity and through the entire system. Only when nonmetal components are used or the electrical continuity is broken can sparks or shocks occur. Use an ohmmeter to check the electrical continuity of the system on a weekly basis as a maintenance item and/or if anyone feels a shock.



- b. Use an ohmmeter to check the electrical continuity of all swivel couplings on a weekly basis as a maintenance item and/or if anyone feels a shock.



Cam Lock



Wand

FIG. 11 CAM LOCK GROUNDING (TYPICAL)

12. **System Filter:**

The system is designed with a large filter in the blower inlet line to stop dirt, dust and contaminants from going through the blower. With the intended operation in dusty and dirty environments, the blower life will not be compromised by contaminants entering the system.

Remove the basket from the bottom of the filter cannister and remove the accumulated material at the start of each day.



Remove the filter and clean at the start of each day. Also, clean the filter whenever the vacuum valve goes over relief. After several cleanings replace the filter.



Filter Assembly



Basket Removed



Filter

FIG. 12 SYSTEM FILTER

WARNING!

Dust buildup can cause explosion and a fire hazard. Never operate the system with filters removed.

13. Receiver Cyclone/Airlock:

The system is designed to direct the system intake airflow into a cyclone receiver where the large, heavy particles fall out into the airlock. The airlock is located under the receiver tank. The collected material drops into an airlock compartment as it turns. As the rotor turns and a compartment moves from its up position to its down position, the material in the rotor compartment will fall out into the hopper bin.



FIG. 13 RECEIVER CYCLONE/AIRLOCK

14. Airlock Unplugging:

If a large piece of debris is drawn into the intake, it can get into the airlock, stall it and have to be removed. To unplug, lock-out tag-out master control panel. Remove obstruction through the access door on the receiver tank. Rotate airlock after obstruction is removed to be sure airlock turns freely and has not been damaged. Repair airlock if damaged before resuming work.



FIG. 14 AIRLOCK ACCESS

15. Lock-Out Tag-Out Procedure:

It is recommended that the customer institute a formal lock-out tag-out procedure for their workplace. In simple terms, this policy would require every person that will be servicing, adjusting, maintaining or unplugging the system to lock out the master panel and place a tag on it before working on the unit. Only the person with the tag can unlock the master switch to allow it to be turned on. This prevents unauthorized people from starting up the system and maintains control by the serviceman working on the system.

16. Secondary Cleaning Cyclone:

The Central Vacuum is designed with a primary cleaning cyclone that removes the majority of the material picked up by the system and removed through the airlock into the bin. In addition, the system is designed with a secondary cyclone to remove additional debris from the airflow before it enters the filter cannister.

The bottom of the secondary cyclone is designed with a flapper door on the bottom of the assembly to remove any accumulated debris. Open flapper door to empty the cyclone at the start of each day for the best results or more often if required.



Cyclone



Flapper Door

FIG. 15 SECONDARY CLEANING CYCLONE

17. Operating Hints:

- a. Lock out tag out master panel before performing any service or maintenance work on machine or unplugging airlock.
- b. Maintain electrical continuity through all components to prevent sparks, shock or electrical discharges. Do not use plastic components.
- c. Clean the intake filter whenever the vacuum relief valve goes off. Replace filter when cleaning frequency is too short.



Filter



Basket

FIG. 16 INTAKE FILTER SYSTEM

- d. Remove obstructions from airlock through access door in receiver tank after the master panel is locked out tagged out.



FIG. 17 AIRLOCK ACCESS DOOR

- e. At the start of each day, open flapper door on the bottom of the secondary cyclone to empty the compartment and minimize the amount of dirt getting to the filter mechanism.



FIG. 18 FLAPPER DOOR

- f. Verify that each female connection has a rubber gasket seal in good condition.



FIG. 19 GASKET SEAL (TYPICAL)

- g. When on top of material, do not push the nozzle into the pile next to the feet. The suction will pull the nozzle and the operator into the pile. If the pile is deep enough, the operator can be submerged under the material and suffocated.

 **DANGER**

Do not place intake tube near feet when standing on top of material. Sufficient material can be removed to draw operator and intake tube into grain. Submersion in grain can cause suffocation.

 **DANGER**

ELECTRO-STATIC HAZARD
To prevent serious injury or death from electro-static discharge:

- Make sure conveying lines and work area are dust and fire hazard free.
- Use original equipment / hoses only.
- Do not use plastic hoses and / or piping, unless those are properly grounded.

IF MACHINE PULSATES EXCESSIVELY, OPEN SLIDE FOR MORE AIR.

53-80781-6



FIG. 20 TUBE NOZZLE

4.7 STORAGE



STORAGE SAFETY

- Store unit in area away from human activity.
- Do not allow children to play on or around the stored Central Vacuum System.
- Lock-out tag-out master control panel to prevent unexpected start-up.

If the machine will not be used for a period of time, the machine should be thoroughly inspected and prepared for storage. Repair or replace any worn or damaged components to prevent any unnecessary down time when it will be used again.

Follow this procedure:

1. Clean the entire machine thoroughly using the Central-Vacuum to remove all dirt, debris or residue.
2. Run the airlock to be sure the primary cyclone is empty and clean.
3. Apply anti-corrosive oil to the blower and the airlock.
4. Open flapper door and clean secondary cyclone.
5. Remove and clean filter basket.
6. Remove and clean filter.
7. Gather all hoses, inlets and wands and store them so they will not be damaged during the down time.
8. Lubricate all grease points. Make sure all grease cavities have been filled with grease prior to storage.
9. Inspect all air hoses, fittings, lines and cam couplers. Tighten any loose fittings. Replace any hose that is badly cut, nicked or abraded or is separating from the crimped end of the fitting.
10. Check the oil level in the blower reservoirs and gearbox. Bring to the recommended level.
11. Install and secure the plugs in the intake line inlets.
12. Touch up all paint nicks and scratches to prevent rusting.

5 SERVICE AND MAINTENANCE



MAINTENANCE SAFETY

- Follow ALL the operating, maintenance and safety information in the manual.
- Support the machine with blocks or safety stands when working beneath it.
- Follow good shop practices:
 - Keep service area clean and dry.
 - Be sure electrical outlets and tools are properly grounded.
 - Use adequate light for the job at hand.
- Use only tools, jacks and hoists of sufficient capacity for the job.
- Before servicing, adjusting, repairing or maintaining unit, ensure that unit power source is completely shut down and can not start up.
- Make sure all guards are in place and properly secured when maintenance work is completed.
- Keep hands, feet, hair and clothing away from all moving and/or rotating parts.
- Lock-out tag-out master control panel before opening airlock access door.
- Lock-out tag-out master control panel before performing any maintenance or service work on machine.
- Clear the area of bystanders, especially small children, when carrying out any maintenance and repairs or making any adjustments.
- Be sure all lines, hoses and wands are grounded when maintenance work is completed.

5.1 SERVICE

5.1.1 FLUIDS AND LUBRICANTS

1. **Grease:**
Use an SAE multi-purpose high temperature grease with extreme pressure (EP) characteristics. Also acceptable is an SAE multipurpose lithium-based grease.
2. **Blower Oil:**
Use Walinga® Blower Oil part number **98-13813-5**.

Reservoir Capacity	
Front	1.4 liters (1.48 qts)
Rear	2.5 liters (2.6 qts)

3. **Gearbox Oil:**
Use 80W90 gear oil for all applications.

Gearbox Capacity
1.0 liters (1.16 qts)

4. **Storing Lubricants:**
Your machine can operate at top efficiency only if clean lubricants are used. Use clean containers to handle all lubricants. Store them in an area protected from dust, moisture and other contaminants.

5.1.2 GREASING

Use the Maintenance Checklist provided to keep a record of all scheduled maintenance.

1. Use only a hand-held grease gun for all greasing. Air powered greasing systems can damage the seals on bearings and lead to early bearing failure.
2. Wipe grease fitting with a clean cloth before greasing to avoid injecting dirt and grit.
3. Replace and repair broken fittings immediately.
4. If a fitting will not take grease, remove and clean thoroughly. Also clean lubricant passageway. Replace fitting if necessary.

5.1.3 SERVICING INTERVALS

8 Hours or Daily

1. Open the flapper valve on the bottom of the secondary cyclone to remove any loose material.
2. Remove the filter basket and empty.



FIG. 21 FLAPPER VALVE/BASKET

3. Clean filter.



FIG. 22 FILTER

4. Check the oil level in the blower reservoirs (2 locations).

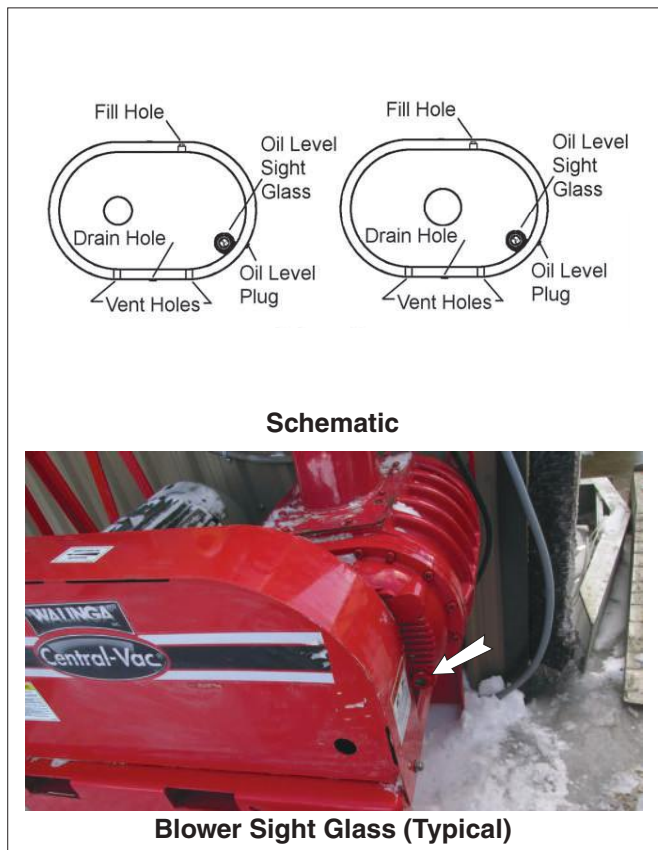

FIG. 23 RESERVOIRS

40 Hours or Weekly

1. Check airlock drive chain. Tension or align as required.



FIG. 24 DRIVE CHAIN

2. Check for component (lines, hoses and wands) grounding. Use an ohmmeter to be sure. Do not operate unless the system is completely grounded.



FIG. 25 COUPLER (TYPICAL)

3. Check gearbox oil level.

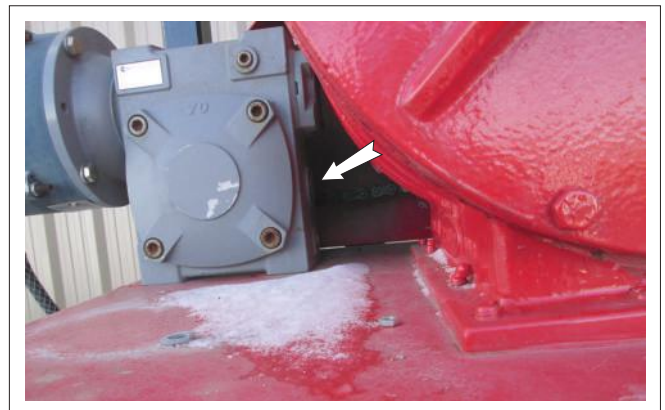

FIG. 26 LEVEL PLUG

6 Months

1. Check the tension and alignment of the input drive belts. See Maintenance Section.



FIG. 27 DRIVE BELTS

2. Service couplings.

100 Hours or Annually

1. Change the oil in the blower reservoirs (2 reservoirs), and clean head plate vent holes.

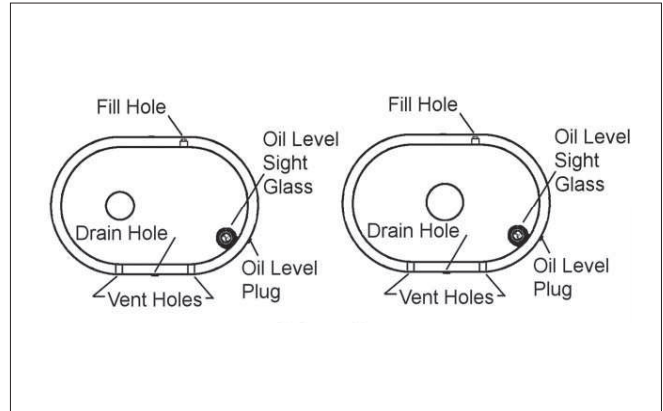

FIG. 28 BLOWER RESERVOIRS

2. Check the function of the vacuum relief valve.



FIG. 29 RELIEF VALVE

3. Check condition of continuity across camlocks.



FIG. 30 CAMLOCKS

4. Change oil in gearbox.



FIG. 31 DRAIN PLUG

5.1.4 SERVICE RECORD

See Lubrication and Maintenance sections for details of service. Copy this page to continue record.

ACTION CODE: CL CLEAN G GREASE CK CHECK
 CH CHANGE S SERVICE

MAINTENANCE													
HOURS													
SERVICED BY													
8 Hours or Daily													
CL Flapper Valve													
CL Filter Basket													
CL Filter													
CK Oil Level in Blow Reservoirs													
40 Hours or Weekly													
CK Drive Belt and Chain Tension													
CK Lines, Hoses and Wands													
CK Gearbox Oil Level													
6 Months													
CK Belt Tension and Alignment													
S Couplings													
100 Hours or Annually													
CH Blower Oil													
CK Vacuum Relief Valve													
CK Camlock Electrical Continuity													
CH Gearbox Oil													

5.2 MAINTENANCE

By following a careful service and maintenance program on your machine, you will enjoy many years of trouble-free use.

5.2.1 BELT TENSION AND ALIGNMENT

Rotational power from the electric motor is transmitted to the blower through the belt drive. To obtain efficient transmission of power and good belt life, the belts must be properly tensioned and the pulleys aligned.

Belts that are too tight will stretch and wear quickly or overload the bearings on the motor or blower. Belts that are too loose will not transmit the required power and will slip, overheat and wear quickly. Pulleys that are not aligned will result in rapid belt wear.

Follow this procedure when checking and adjusting belt tension and pulley alignment.

1. Clear the area of bystanders, especially small children.
2. Turn machine off, lock out tag out master control panel and wait for all moving parts to stop before starting maintenance work.
3. Unlatch and remove the belt cover. Lay to the side.
4. Use the appropriate weight to determine the belt deflection in a static condition (Table 1).



FIG. 32 BELT COVER

Table 1 BELT DEFLECTION

Model	Weight Range	Deflection
10 HP (75 KW)	3.8 - 5.7 lbs (1.7 - 2.6 kg)	5/16" (7.9 mm)
15, 20, 25 HP (112, 149, 186 KW)	6.5 - 9.6 lbs (2.9 - 4.4 kg)	5/16" (7.9 mm)

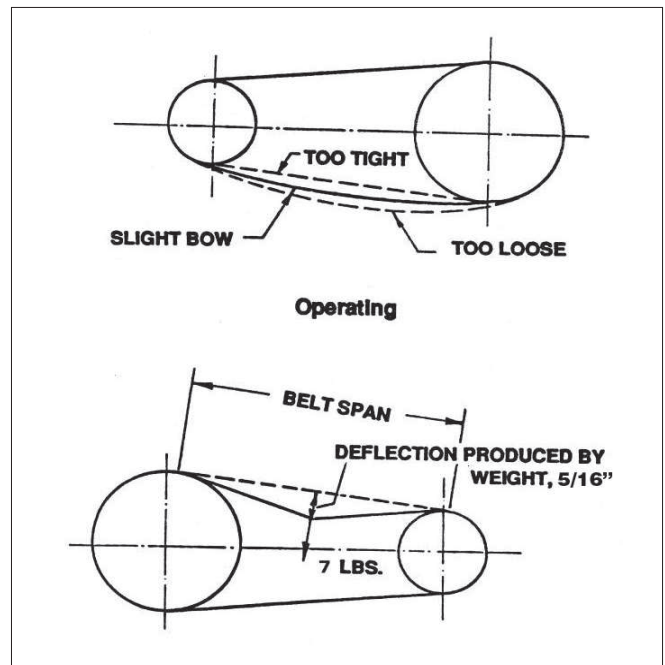

FIG. 33 BELT DEFLECTION

5. Adjusting Tension:

- a. Loosen the jam nuts on the motor base and position adjusting bolts. Loosen base position bolts slightly.
- b. Turn the adjusting bolt to set the tension. Turn both bolts the same amount to maintain pulley alignment.
- c. Check the tension again. Overtightening will cause belt stretching and overload the bearing. Belts that are too loose will slip, tear and wear rapidly. Check alignment, see next section.
- d. Tighten base position bolts.
- e. Tighten jam nuts.
- f. Install and secure belt covers.

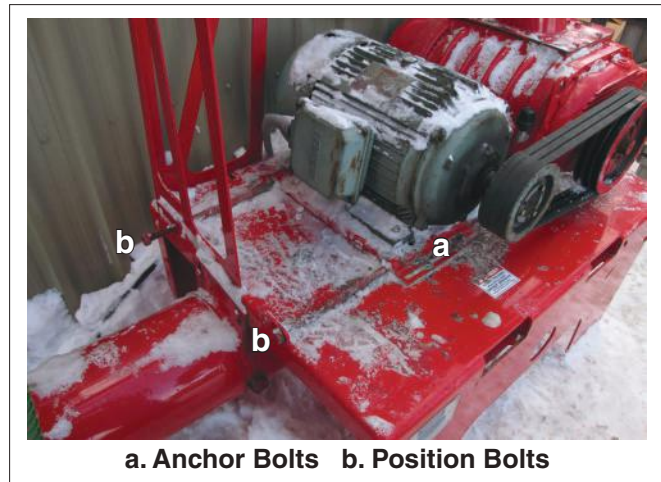

FIG. 34 TENSIONING



6. Pulley Alignment:

- a. Lay a straight-edge across the faces of the two pulleys.
- b. If the gap between the pulley and the straight-edge exceeds 1/16 inch (1.5 mm), the pulleys must be realigned.



FIG. 35 PULLEYS

c. Review the types of alignment before starting.

1. Shafts are not parallel to one another.

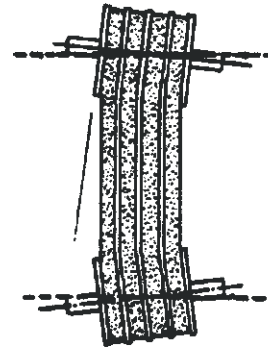

2. Shafts are not in correct alignment although they appear parallel when seen from above.

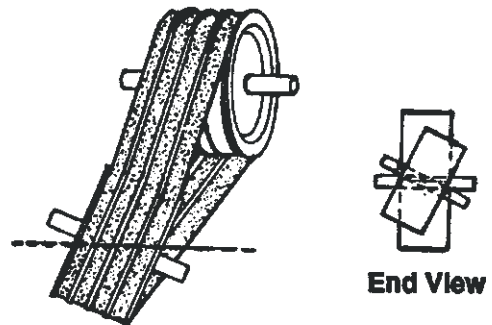

3. Shafts are parallel and in alignment but pulleys are not in alignment.

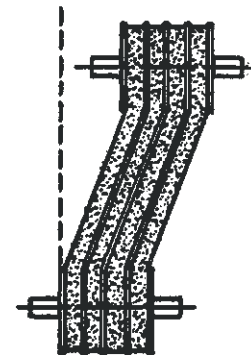

4. Correct installation both shafts and pulleys are parallel and in alignment.

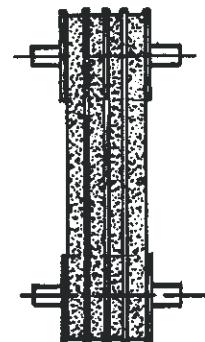

FIG. 36 MISALIGNMENT

- d. Use the position adjusting bolts on the motor base to align the input pulley. Tighten motor base anchor bolts and jam nuts when alignment has been completed.
- e. Set the belt tension.

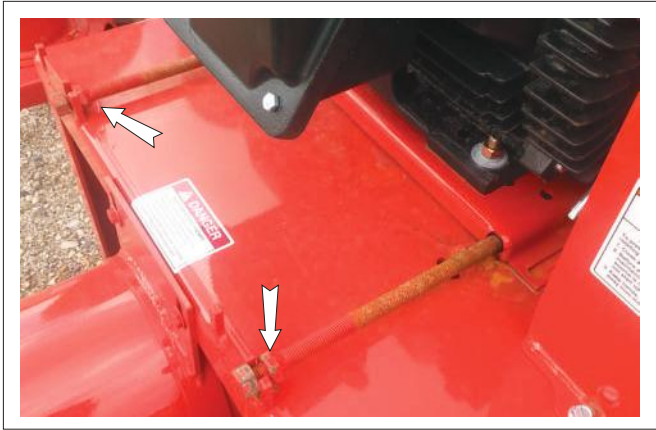

FIG. 37 ADJUSTING BOLTS

- f. Install and latch belt cover.
7. Be sure all guards are installed and secure before resuming work.



5.2.2 CHANGING BLOWER OIL AND CLEANING BREATHER

The gears that drive and time the blower lobes run in an oil bath for lubrication. Maintaining the correct level in the reservoirs and changing every 100 hours will insure proper lubrication.

When maintaining the blower, follow this procedure:

1. Clear the area of bystanders, especially small children.
2. Turn machine off, lock out tag out master control panel and wait for all moving parts to stop before starting maintenance work.
3. Unlatch and remove the belt drive covers.
4. Checking Oil Level:
 - a. Remove the level plug in each reservoir or check the sight glass.

IMPORTANT

Check the level only when the oil is cold and the machine is level.

- b. Oil in the reservoir should just fill the threads of the level plug hole.
- c. Add oil if low or allow the reservoir to drain if overfilled.

IMPORTANT

It is necessary to maintain the recommended oil level in the reservoir. A low level causes heating from lack of lubrication and rapid gear and bearing wear. Too much oil causes heating from oil churning and can cause seal and breather leaks.

- d. Install and tighten the level plug.
- e. Install and secure the belt covers.

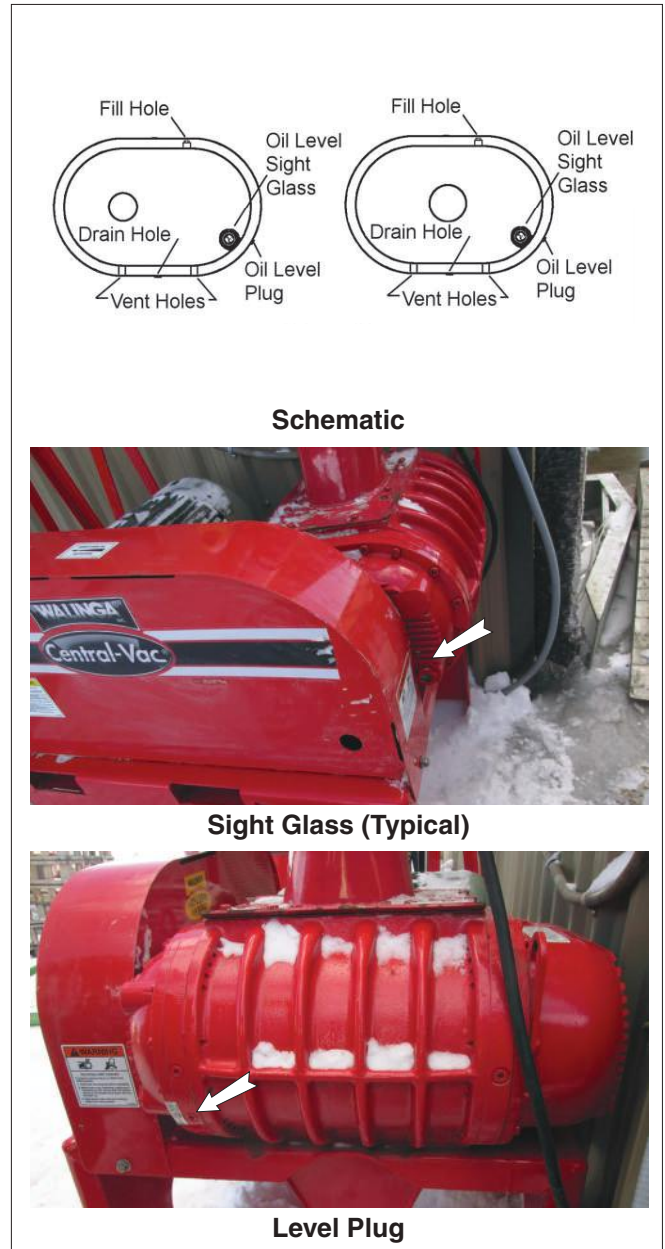

FIG. 38 BLOWER OIL LEVEL

5. Changing Oil:

- a. Place a collection pan or pail under each drain plug.
- b. Remove each drain plug.
- c. Flush each case and allow several minutes to drain.
- d. Dispose of the oil in an approved manner. Do not contaminate the worksite with used oil.
- e. Install and tighten the drain plugs.
- f. Remove fill and level plugs.
- g. Add Walinga® Blower Oil or equivalent to each reservoir until the oil is just starting to come out of the level plug hole.

IMPORTANT

Condensation forms and collects inside the reservoirs during machine operation. Changing oil removes this water and prevents it from damaging the gears and bearings.

- h. Install and tighten the level and fill plugs.
- i. Install and secure the belt drive covers.

6. Cleaning Breathers:

- a. Remove breathers and blow out with an air hose.
- b. If dirt has caked up in the breather, soak in good solvent and then blow out. It may be necessary to use a probe to loosen the dirt.
- c. Install and tighten the breather.
- d. Install and secure the belt drive covers.
- e. Clean vents in end plates located under the blower on either side of the drain plug.

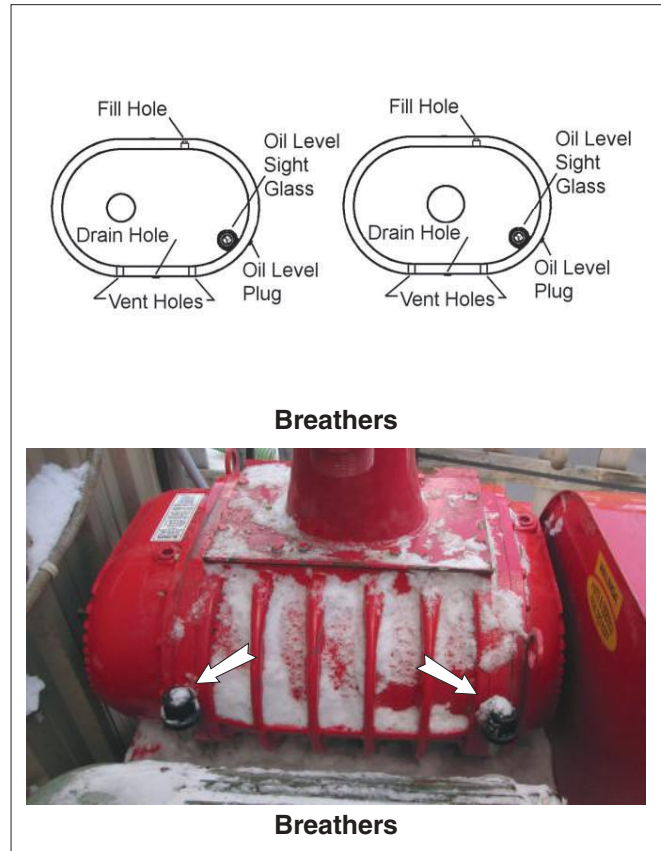
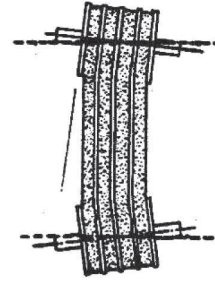

FIG. 39 BLOWER

7. Pulley Alignment:

- a. Lay a straight-edge across the faces of the two pulleys.
- b. If the gap between the pulley and the straight-edge exceeds 1/16 inch (1.5mm), the pulleys must be realigned.
- c. Measure the distance the pulley needs to move.
- d. Loosen belts.
- e. Remove bolts from the pulley which is to be moved.
- f. Install bolts into pulleys' threaded holes and force pulley from bushing. Use all bolts with equal force to ensure that bushing is not damaged.
- g. Move bushing as per measurement required.
- h. Re-install sheave onto bushing.
- i. Re-install belts.

1. Shafts are not parallel to one another.



2. Shafts are not in correct alignment although they appear parallel when seen from above.

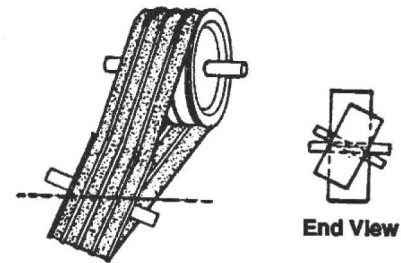

3. Shafts are parallel and in alignment but pulleys are not in alignment.

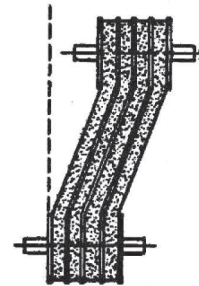

4. Correct installation both shafts and pulleys are parallel and in alignment.

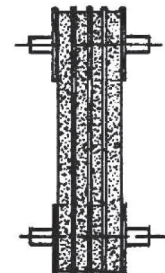

FIG. 40 BELT ALIGNMENT

5.2.3 AIRLOCK

The airlock acts as a seal between the vacuum and atmosphere sides of the machine and is located at the bottom of the collector cyclone tank. As the airlock rotor turns, a pocket is filled with material when it points upward. As the pocket rotates, material is moved to the bottom where the material drops out of the pocket into the discharge pipe.

Efficient operation of the airlock requires a close fit between the tips of the rotor and the case to maintain a seal between vacuum and atmosphere sides.

When checking or maintaining the airlock, follow this procedure:

1. Clear the area of bystanders, especially small children.
2. Turn machine off, lock out tag out master control panel and wait for all moving parts to stop before starting maintenance work.



3. Checking Tip Clearance:

- a. Checking the airlock can be done through the inspection door.
- b. Use a feeler gauge to check the clearance between the tip and the case. Inspect each tip over its entire width.
- c. The clearance of the tips must be maintained at 0.004 to 0.006 inches at all times. Adjust or replace tips as required to insure system sealing.
- d. Replace any tips that are bent, chipped or broken.

NOTE

Blades are reversible if not excessively damaged.

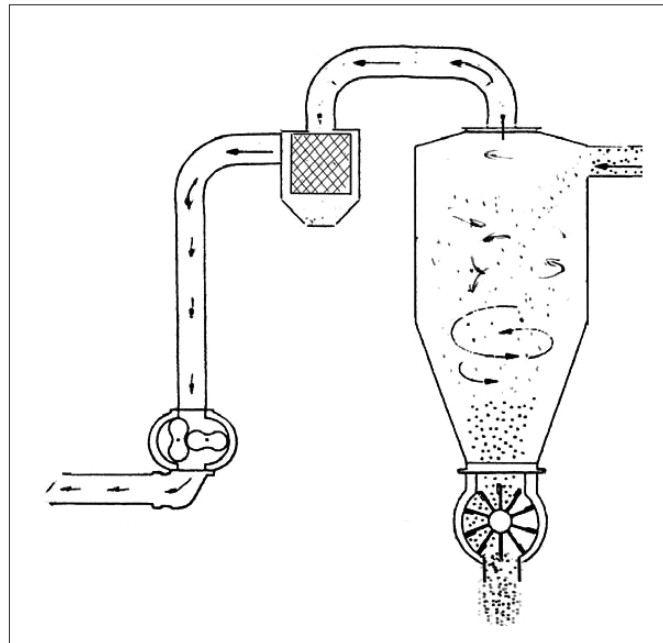
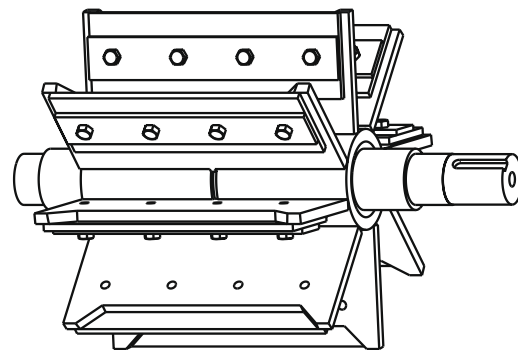

FIG. 41 AIRLOCK



Airlock



Drawing

FIG. 42 AIRLOCK

4. **Wiper Blade:**

A wiper blade is located at the top of the airlock to clean the tips as the airlock turns.

To check the wiper blade, follow this procedure:

- a. Open the access door on receiver tank.
- b. Reach into the top of the airlock and feel the condition of the wiper blade.
- c. Replace it if it is damaged in any way.

5. **Blade Replacement:**

- a. **Lock out tag out master control panel.**
- b. Remove chain drive guard.
- c. Lift the collector cyclone off the airlock.
- d. Remove collector cyclone anchor bolts.
- e. Remove the tips from the rotor and the wiper blade from the housing.
- f. File the ends of each replacement blade so there is approximately 0.006 inches of clearance between the ends and the housing.
- g. Mount the blades to their respective vane and tighten bolts finger tight.
- h. Loosen and remove drive chain.
- i. Rotate airlock rotor slightly to set the clearance between the blade and the case. Be sure to set it at 0.004 inches of clearance. Use a feeler gauge.
- j. Tighten the center bolt first. Then the others.
- k. Rotate the airlock and listen if it touches the housing anywhere. A slight touch is alright.
- l. Repeat mounting procedure with the other blades.
- m. Turn the rotor after each blade is installed to be sure it does not contact the case.
- n. Mount the new wiper blade. Be sure the wiper contacts each tip slightly as the airlock turns.
- o. Install and set chain drive tension.
- p. Install and secure chain drive guard.
- q. Clean thoroughly.



Mounted

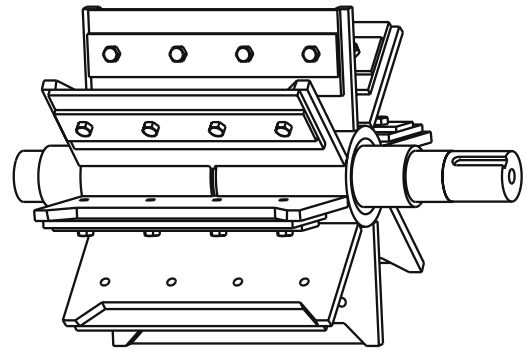

Schematic

FIG. 43 AIRLOCK



5.2.4 CHAIN TENSION

Rotational power to drive the airlock is provided by an electric motor through a chain drive system. To obtain good chain life, the chain must be properly tensioned and the sprockets aligned. Chains that are too tight will stretch and wear quickly or over load the bearings. Chains that are too loose will not transmit the power evenly and will wear out quickly. Misaligned sprockets will rapidly wear the chain and sprockets.

When checking chain tension and alignment, follow this procedure:

1. Clear the area of bystanders, especially small children.
2. Turn machine off, lock out tag out master control panel and wait for all moving parts to stop before starting maintenance work.
3. Remove guard over chain drive system.
4. Pull on the middle of the slack side of the chain. The chain is properly tensioned when the chain will move 1/4 inch (6 mm).
5. **Adjusting Tension:**
 - a. Loosen the gearbox mounting bolts.
 - b. Slide or tap gearbox to provide required chain tension.
 - c. Tighten gearbox mounting bolt.
 - d. Install and secure chain guard.

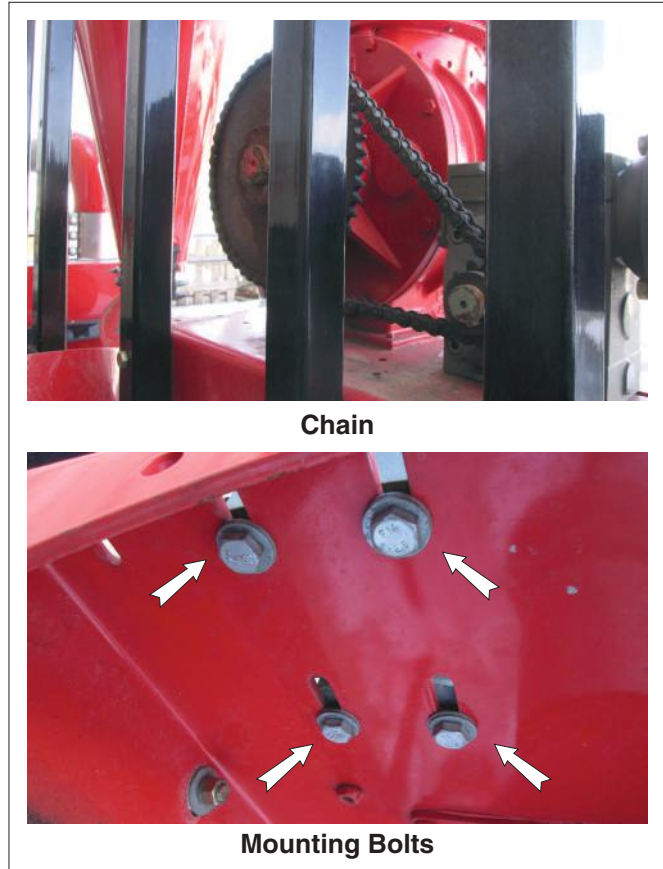

FIG. 44 CHAIN TENSIONING



6. **Sprocket Alignment:**

- a. Lay a straight edge along the sides of the 2 sprockets.
- b. If there is a gap of more than 1/16 inch (1.5 mm) between the sprockets and straight edge, the sprockets must be aligned.
- c. Use the gearbox position to move sprocket for alignment.
- d. Be sure chain is properly tensioned.
- e. Tighten gearbox mounting bolts when alignment set.
- f. Install and secure chain guard.



FIG. 45 CHAIN ALIGNMENT

5.2.5 GEARBOX OIL

The airlock is driven by an electric motor that is attached to a gearbox attached to the airlock. The gearbox is equipped with a drain, level and fill plug. Every 40 hours, the oil level should be checked. Every 100 operating hours or annually, whichever comes first, the oil should be replaced. Check more frequently if there are leaks around any of the plugs or shaft seals. When checking oil level or changing oil, follow this procedure (Refer to manufacturer's manual or Walinga® blower oil.):

1. Run the machine until the gearbox is warm. Warm oil will remove more contaminants than cold, stagnant oil.
2. Stop machine.
3. Place all controls in their OFF position and wait 30 seconds for the airlock to stop turning.
4. Turn power OFF at master control panel and lock-out tag-out.
5. **Checking Oil Level:**
 - a. When the gearbox is cold, remove the level plug from the side of the gearbox.
 - b. When the oil just fills the threads of the level plug, it is at the correct level.
 - c. Add oil through the fill plug as required.
 - d. Install and tighten level and fill plugs.
6. **Changing Oil:**
 - a. Place pan under drain plug.
 - b. Remove drain plug.
 - c. Remove fill plug.
 - d. Install and tighten drain plug when oil stops draining.
 - e. Fill with specified oil.
 - f. Tighten fill plug.

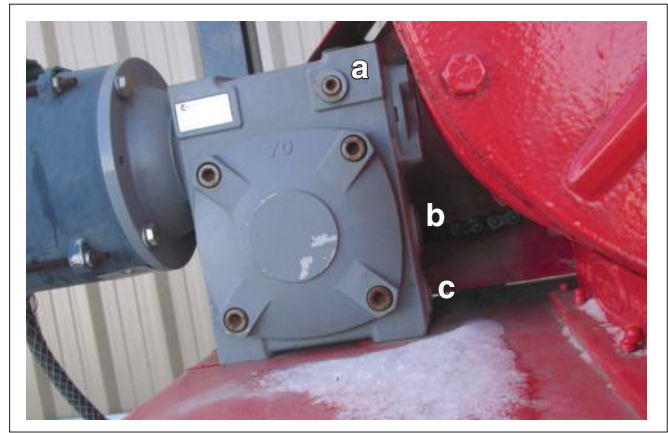

FIG. 46 GEARBOX

6 TROUBLE SHOOTING

The Walinga® Central Vacuum System is a high capacity air pump that creates a vacuum for picking up granular material and supplies pressurized air for moving the material. It is a simple and reliable system that requires minimum maintenance.

In the following section, we have listed many of the problems, causes and solutions to the problems that you may encounter.

If you encounter a problem that is difficult to solve, even after having read through this trouble shooting section, please call your Walinga® dealer. Before you call, please have this Operator's Manual and the serial number from your Central Vacuum System ready.

PROBLEM	CAUSE	SOLUTION
Slow pick-up of material.	Air leaks.	Tighten all vacuum connections. Be sure cam locks are in good condition. Tighten receiver cyclone to base. Check airlock for tip wear. Check seal on pre-cleaner bottom door. Close and secure. Inspection door must be closed and sealed. Check if piping is plugged. Check vacuum relief valve. Replace if defective. Clear obstruction.
	Dirty or plugged intake filter. Defective blower.	Clean or replace intake filter. Check clearance between lobes and case. Excessive clearance will decrease airflow. Consult your dealer.
Slow discharge of material.	Improper setting of air slide.	Reset air slide.
	Air leaks.	Tighten all pressure connections. Be sure cam locks are in good condition.
	Dirty or plugged intake filter. Defective blower.	Clean or replace intake filter. Check clearance between lobes and case. Excessive clearance will decrease airflow. Consult your dealer.
Excessive filter plugging.	Defective airlock.	Check tips.
	Air leaks.	Check seal between tanks.
Pulsation.	Not enough airflow.	Open air slide on wand to provide more air or allow more air into intake.
	Too many bends in hose.	Straighten out intake hose.
Blower overheating.	Not enough airflow.	Open air slide on wand to provide more air or allow more air into intake.
	Low oil level.	Add oil as required.
Noisy airlock.	Tips hitting case.	Readjust tips where applicable.

PROBLEM	CAUSE	SOLUTION
Airlock stalls.	Airlock jammed.	Remove obstruction from airlock by opening inspection door or discharge line. Lock-out tag-out master control panel.
	Blades too tight.	Loosen bolts. Refer to airlock maintenance.
	Faulty airlock motor or gearbox.	Replace motor or gearbox as required.
Air loss through airlock.	Tip clearance too large.	Adjust tips to decrease clearance to at least 0.006 inches.
Breaking rotor blades.	Blades too tight.	Loosen bolts. Refer to airlock maintenance.
Low air volume.	Slow speed.	Check for slipping belts. Adjust belt tension as required.
	Belt slip.	Adjust belt tension as required.
	Filter plugged.	Check relief valve. Clean, repair or replace as required.
	Worn components.	Clean filter.
		Check clearance and replace defective components. Refer to Blower Manual.
Overheating.	Inadequate lubrication.	Check oil level in reservoirs. Add as required.
	Excessive lubrication.	Check oil level. Correct as required.
	Coupling misalignment.	Check and realign.
Motor overloading.	Impellers rubbing.	Consult your nearest dealer.
Loss in drive speed.	Belts slipping.	Tighten belts as required.
	Localized belt wear.	Check cross-section dimension. a. If narrow, pulley spinning. b. If swollen, belt failing internally.
	Unequal stretch on belts.	Defective belts. Replace with matched sets.
	Belts overloaded.	Belts failed or worn out. Replace belts and set correctly.
	Belt separation.	Belts too tight. Replace belts and set correctly
	Envelope seams opening.	Check for oil or rubber solvent. Eliminate contamination and replace belts.
	Abnormal envelope wear.	Check for worn sheave, misalignment or slip. Replace defective parts, adjust properly and replace belt.
	Belt softening or swelling.	Eliminate oil or rubber solvent. Replace belt.



PROBLEM	CAUSE	SOLUTION
Loss in drive speed (cont.)	Belt hardening or cracking.	Eliminate heat or chemical contamination. Replace belt.

7 SPECIFICATIONS

7.1 MECHANICAL

7.1.1 Mechanical Specifications:

7.1.2 Capacities:

SPECIFICATIONS SUBJECT TO CHANGE WITHOUT NOTICE

7.2 BOLT TORQUE

CHECKING BOLT TORQUE

The tables shown below give correct torque values for various bolts and capscrews. Tighten all bolts to the torques specified in chart unless otherwise noted. Check tightness of bolts periodically, using bolt torque chart as a guide. Replace hardware with the same strength bolt.

ENGLISH TORQUE SPECIFICATIONS

Bolt Diameter "A"	Bolt Torque*					
	SAE 2		SAE 5		SAE 8	
	(N.m.)	(lb-ft)	(N.m.)	(lb-ft)	(N.m.)	(lb-ft)
1/4"	8	6	12	9	17	12
5/16"	13	10	25	19	36	27
3/8"	27	20	45	33	63	45
7/16"	41	30	72	53	100	75
1/2"	61	45	110	80	155	115
9/16"	95	60	155	115	220	165
5/8"	128	95	215	160	305	220
3/4"	225	165	390	290	540	400
7/8"	230	170	570	420	880	650
1"	345	225	850	630	1320	970

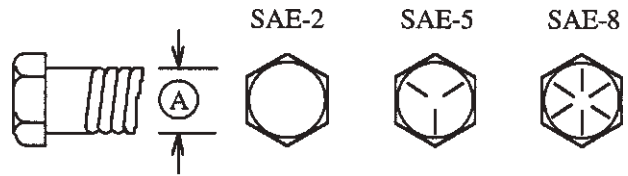

METRIC TORQUE SPECIFICATIONS

Bolt Diameter "A"	Bolt Torque*			
	8.8		10.9	
	(N.m.)	(lb-ft)	(N.m.)	(lb-ft)
M3	.5	.4	1.8	1.3
M4	3	2.2	4.5	3.3
M5	6	4	9	7
M6	10	7	15	11
M8	25	18	35	26
M10	50	37	70	52
M12	90	66	125	92
M14	140	103	200	148
M16	225	166	310	229
M20	435	321	610	450
M24	750	553	1050	774
M30	1495	1103	2100	1550
M36	2600	1917	3675	2710

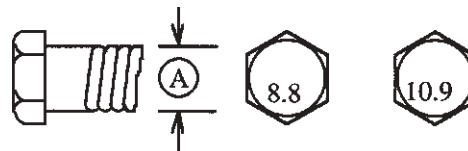

Torque figures indicated above are valid for non-greased or non-oiled threads and heads unless otherwise specified. Therefore, do not grease or oil bolts or capscrews unless otherwise specified in this manual. When using locking elements, increase torque values by 5%.

* Torque value for bolts and capscrews are identified by their head markings.

8 PARTS

Elbows, TY'S , Galvanized

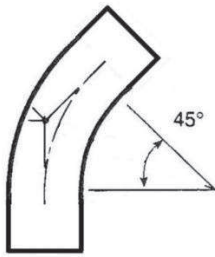

ELBOWS, 45 °, GALVANIZED

PART NO	DESCRIPTION
51-80287-6	2" X .065" Wall X 5" CLR - Straight Ends
51-18904-6	3" X .065" Wall X 7 1/2" CLR - Straight Ends
51-18905-6	4" X .065" Wall X 10" CLR- Straight Ends
51-07288-6	5" X .065" Wall X 10" CLR - Straight Ends
51-90124-6	6" X .065" Wall X 15" CLR - Straight Ends

Elbows, 90 °, Galvanized

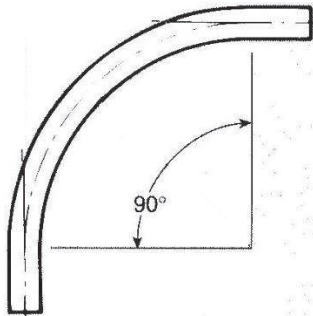

PART NO	DESCRIPTION
51-80282-6	2" X .065" Wall X 5" CLR- Straight Ends
51-80283-6	2" X .065" Wall X 18" CLR - Straight Ends
51-80284-6	2" X .065" Wall X 24" CLR - Straight Ends
51-18949-6	3" X .065" Wall X 7 1/2" CLR - Straight Ends
51-18956-6	3" X .065" Wall X 24" CLR- Straight Ends
51-18957-6	3" X .065" Wall X 30" CLR- Straight Ends
51-80285-6	4" X .065" Wall X 10" CLR- Straight Ends
51-18961-6	4" X .065" Wall X 24" CLR - Straight Ends
51-18963-6	4" X .065" Wall X 36" CLR- Straight Ends
51-80286-6	5" X .065" Wall X 12 1/2" CLR - Straight Ends

90 ° TY'S, GALVANIZED

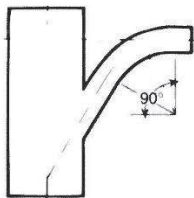

PART NO	DESCRIPTION
51-80290-6	2" Straight W/ 2" Inlet, .065 Wall - Straight Ends
51-80291-6	3" Straight W/ 2" Inlet, .065 Wall - Straight Ends
51-18910-6	3" Straight W/ 3" Inlet, .065 Wall - Straight Ends
51-80292-6	4" Straight W/ 2" Inlet, .065 Wall - Straight Ends
51-18901-6	4" Straight W/ 3" Inlet, .065 Wall - Straight Ends
51-18485-6	4" Straight W/ 4" Inlet, .065 Wall - Straight Ends

Double 90 TY's, Double 90 Y's, Galvanized, Tips, Tip Clamps

DOUBLE 90° TY's, GALVANIZED

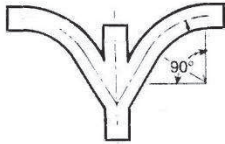

PART NO	DESCRIPTION
51-80294-6	2" Straight W/ 2" Inlets, .065 Wall - Straight Ends
51-18917-6	3" Straight W/ 3" Inlets, .065 Wall - Straight Ends
51-18918-6	4" Straight W/ 4" Inlets, .065 Wall - Straight Ends

DOUBLE 90° Y's, GALVANIZED

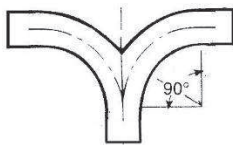

PART NO	DESCRIPTION
51-80293-6	2" .065 Wall - Straight Ends
51-18923-6	3" .065 Wall - Straight Ends
51-18535-6	4" .065 Wall - Straight Ends

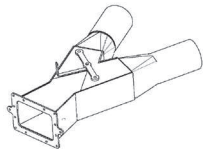

DIVERTER VALVES

PART NO	DESCRIPTION
11-81445-5	6" Diverter Valve, 1210 DT Hook-Up

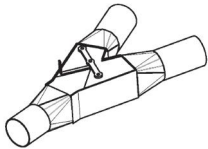

DIVERTER VALVES

PART NO	DESCRIPTION
11-81406-5	6" Diverter Valve, 6" Inlet, 6" Outlet



AIRLOCK FLEX TIP

PART NO	DESCRIPTION
30-75955-4	Airlock Tip, Flex, 1210DT, 9 3/8" LG



TIP CLAMP

PART NO	DESCRIPTION
30-75957-4	Tip Clamp 1210 Rotor, Short Tip

Reducing Couplers, Adaptors, Compression Couplers



REDUCING COUPLINGS

PART NO	DESCRIPTION
51-80280-6	Reducer; Galvanized, 3" To 2" .065 Wall Straight Ends
51-80281-6	Reducer; Galvanized, 4" To 2" .065 Wall Straight Ends
51-18929-6	Reducer; Galvanized, 4" To 3" .065 Wall Straight Ends



COUPLING , ADAPTORS

PART NO	DESCRIPTION
38-80297-6	Adaptor; KM3 TO KF2
38-43218-6	Adaptor; DM4 TO KF2
38-43219-6	Adaptor; DM4 TO KF3



COMPRESSION COUPLINGS

PART NO	DESCRIPTION
38-80278-6	Coupling; Compression 2", 3 Bolt, Black Gasket, Grounding Strip
38-80279-6	Coupling; Compression 3", 3 Bolt, Black Gasket, Grounding Strip
38-13084-6	Coupling; Compression 4", 3 Bolt, Black Gasket, Grounding Strip
38-08786-6	Coupling; Compression 5", 3 Bolt, Black Gasket, Grounding Strip
38-08523-6	Coupling; Compression 6", 3 Bolt, Black Gasket, Grounding Strip

Operator Tools For 2 inch Hose, Tool Holder



WANDS

PART NO	DESCRIPTION
38-43216-5	Wand 56 " Steel With KM2 Coupling

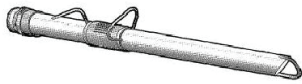

GAYLORD WAND

PART NO	DESCRIPTION
38-68000-6	Wand, Gaylord 11ga X 51 " Aluminum With KM2 Coupling



CREVICE TOOL

PART NO	DESCRIPTION
38-43217-5	Crevice Tool 24" Chrome Steel With KM2 Coupling



GULPER

PART NO	DESCRIPTION
38-18530-6	Gulper Tool 13" Aluminum



SQUEEGEE GULPER

PART NO	DESCRIPTION
38-40507-5	22" Squeegee Gulper C/W Scraper Blade, Aluminum



BRUSH, WALL

PART NO	DESCRIPTION
38-95604-5	9 " Wall Brush KM2

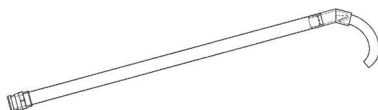

PIPE BRUSH

PART NO	DESCRIPTION
38-72057-5	Pipe Brush, Crescent Wand 2" x 18" w/km2



SQUEEGEE BRUSH / WAND

PART NO	DESCRIPTION
38-72058-5	20" Brush Tool C/W Wand & Wheels

Operator Tools for 3 inch Hose, Self-dumping Hopper Bins, Tool Holders, Filter



TOOL HOLDERS

PART NO	DESCRIPTION
11-47413-5	2" Tool & Hose Holder Rack
11-83065-5	3" Tool & Hose Holder Rack



SWEEP

PART NO	DESCRIPTION
38-37825-5	3" Nozzle With Aluminum Sweep With KM3 Coupling



NOZZLE

PART NO	DESCRIPTION
38-37815-5	Suction Nozzle 20 ° 3" X 37" With KM3 Coupling



INTAKE FILTER

PART NO	DESCRIPTION
11-15427-6	Intake Filter, 13.75" diameter by 16" LG

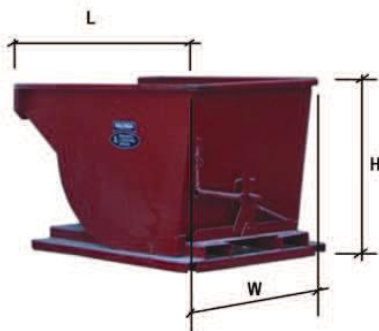

SELF-DUMPING HOPPER BINS

PART NO	DESCRIPTION				
	10 ga Steel Hopper, Self Dump C/W Safety Chains				
	Capacity (CY)	L (in)	W (in)	H (in)	Steel Lid (Optional) Part No
11-78297-6	.5	47	33	31	11-78281-6
11-64331-6	1	59	40	38	11-78280-6
11-78298-6	1.5	63	52	42	11-78282-6
11-78196-6	2	70	58	44	11-78197-6
11-70845-6	3	80	64	50	11-106955-6
11-78299-6	4	78	84	50	11-78296-6
11-78324-6	5	90	76	60	
11-78325-6	6	91	88	60	

**Rubber Hose, Black with Static Wire,Steel Tubing
Clear Hose, with Static Wire,Steel Tubing**



**RUBBER HOSE, BLACK WITH
STATIC WIRE**

PART NO	DESCRIPTION
73-82311-6	2 " Rubber Hose, Black With Static Wire
36-15194-6	3 " Rubber Hose, Black With Static Wire



**RUBBER HOSE BLACK WITH STATIC
WIRE & CAMLOCK BOTH ENDS**

PART NO	DESCRIPTION
36-41037-5	2 " Rubber Hose, Black X 25 Ft W/KM2 & KF2
36-40505-5	3 " Rubber Hose, Black X 12 Ft W/KM3 & KF3
36-41039-5	3 " Rubber Hose, Black X 20 Ft W/KM3 & KF3



CLEAR HOSE, WITH STATIC WIRE

PART NO	DESCRIPTION
36-75496-6	2 " Clear Hose With Static Wire
36-78277-6	3 " Clear Hose With Static Wire



**CLEAR HOSE WITH STATIC WIRE KM
CAMLOCK 1 END & KF SWIVEL END**

PART NO	DESCRIPTION
36-78445-5	2 " VHD Hose X 25 Ft W/KM2 & KF2 Swivel
36-91117-5	3 " VHD Hose X 12 Ft W/KM3 & KF3 Swivel



**CLEAR HOSE WITH STATIC WIRE
& CAMLOCK BOTH ENDS**

PART NO	DESCRIPTION
36-98302-5	2 " VHD Hose X 25 Ft W/KM2 & KF2
36-78483-5	3 " VHD Hose, X 12 Ft W/KM3 & KF3

TUBING



PART NO	DESCRIPTION
89-80295-1	Tube; Steel-Aluminized, 2" OD. X .065" Wall
89-16436-2	Tube; Aluminum, 2" OD. X .120 Wall
89-80296-1	Tube; Steel-Aluminized, 3" OD. X .065" Wall
89-15203-2	Tube; Aluminum, 3" OD. X .120 Wall
89-17452-1	Tube; Galvanized, 4" OD. X .065" Wall
89-00392-2	Tube; Aluminum, 4" OD. X .072 Wall
89-08073-2	Tube; Aluminum, 5" OD. X .078 Wall
89-16222-2	Tube; Aluminum, 6" OD. X .125 Wall

Camlock Couplers



COUPLINGS, MALE, QUICK-CONNECT

PART NO	DESCRIPTION
38-18883-6	Coupling; Camlock, Male, Aluminum, 2" ID (KM2-Tube)
38-18152-6	Coupling; Camlock, Male, Aluminum, 3" ID (KM3-Tube)



38-18881-6	Coupling; Camlock, Male, Aluminum, 2" Hose Shank (KM2-Hose)
38-13998-6	Coupling; Camlock, Male, Aluminum, 3" Hose Shank (KM3-Hose)



38-00397-5	Coupling; Walinga, Male, 4" ID (DM4)
------------	--------------------------------------



COUPLINGS, FEMALE, QUICK-CONNECT

PART NO	DESCRIPTION
38-18882-6	Coupling; Camlock, Female, Aluminum, 2" Hose Shank (KF2-Hose)
38-13999-6	Coupling; Camlock, Female, Aluminum, 3" Hose Shank (KF3-Hose)



38-19043-6	Coupling; Camlock, Aluminum, Female, 2" ID (KF2-Tube)
38-18153-6	Coupling; Camlock, Aluminum, Female, 3" ID (KF3-Tube)

Couplings, Dust Plugs, Saddle Clamps, Brackets, Tube Hanger



COUPLINGS, FEMALE, QUICK-CONNECT

PART NO	DESCRIPTION
38-36781-5	Coupling; Walinga, Female, 4" ID (DF4-Tube)



94-09185-5	Tailbolt; (2 Required For Each DF4 Coupling)
------------	--



DUST PLUG WITH CHAIN

PART NO	DESCRIPTION
38-18880-6	Dust Plug; 2" (KP2)
38-13204-6	Dust Plug; 3" (KP3)



PART NO	DESCRIPTION
38-04465-5	Dust Plug; 4" (DP4)



CLAMP, SADDLE, GALVANIZED

PART NO	DESCRIPTION
28-16800-6	Clamp; Saddle, 2"
28-04673-6	Clamp; Saddle, 3"
28-02074-6	Clamp; Saddle, 4"
28-04675-6	Clamp; Saddle, 5"



TUBE HANGER, GALVANIZED

PART NO	DESCRIPTION
28-65182-6	Tube Hanger, 3" Galvanized
28-65183-6	Tube Hanger, 4" Galvanized





BRACKET, ALUMINUM

PART NO	DESCRIPTION
38-39510-4	Bracket; Aluminum (For 4" Saddle Clamp)



BRACKET, STANDOFF

PART NO	DESCRIPTION
38-07612-6	1.25 " Bin Standoff Bracket; For 3"-6" Tube

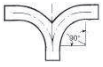
CENTRAL VAC ACCESSORY & PIPING REQUIREMENTS			
Qty	Part Number	Description	
	51-80287-6	Elbow; Galvanized, 45 Deg. 2" X .065" Wall X 5" CLR- Straight Ends	
	51-18904-6	Elbow; Galvanized, 45 Deg. 3" X .065" Wall X 7 1/2" CLR - Straight Ends	
	51-18905-6	Elbow; Galvanized, 45 Deg. 4" X .065" Wall X 10" CLR - Straight Ends	
	51-80288-6	Elbow; Galvanized, 45 Deg. 5" X .065" Wall X 12 1/2" CLR - Straight Ends	
	51-90134-6	Elbow; Galvanized, 45 Deg. 6" X .065" Wall X 15" CLR - Straight Ends	
	51-80282-6	Elbow; Galvanized, 90 Deg. 2" X .065" Wall X 5" CLR - Straight Ends	
	51-80283-6	Elbow; Galvanized, 90 Deg. 2" X .065" Wall X 18" CLR - Straight Ends	
	51-80284-6	Elbow; Galvanized, 90 Deg. 2" X .065" Wall X 24" CLR - Straight Ends	
	51-18949-6	Elbow; Galvanized, 90 Deg. 3" X .065" Wall X 7 1/2" CLR - Straight Ends	
	51-18956-6	Elbow; Galvanized, 90 Deg. 3" X .065" Wall X 24" CLR - Straight Ends	
	51-18957-6	Elbow; Galvanized, 90 Deg. 3" X .065" Wall X 30" CLR - Straight Ends	
	51-80285-6	Elbow; Galvanized, 90 Deg. 4" X .065" Wall X 10" CLR - Straight Ends	
	51-18961-6	Elbow; Galvanized, 90 Deg. 4" X .065" Wall X 24" CLR - Straight Ends	
	51-18963-6	Elbow; Galvanized, 90 Deg. 4" X .065" Wall X 36" CLR - Straight Ends	
	51-80286-6	Elbow; Galvanized, 90 Deg. 5" X .065" Wall X 12 1/2" CLR - Straight Ends	
	51-80290-6		2" Straight W/ 2" Inlet, .065 Wall – Straight Ends
	51-80291-6		3" Straight W/ 2" Inlet, .065 Wall – Straight Ends
	51-18910-6		3" Straight W/ 3" Inlet, .065 Wall – Straight Ends
	51-80292-6		4" Straight W/ 2" Inlet, .065 Wall – Straight Ends
	51-18901-6		4" Straight W/ 3" Inlet, .065 Wall – Straight Ends
	51-18485-6		4" Straight W/ 4" Inlet, .065 Wall – Straight Ends
	51-80294-6		2" Straight W/ 2" Inlets, .065 Wall – Straight Ends
	51-18917-6		3" Straight W/ 3" Inlets, .065 Wall – Straight Ends
	51-18918-6		4" Straight W/ 4" Inlets, .065 Wall – Straight Ends
	51-80293-6		2" .065 Wall - Straight Ends
	51-18923-6		3" .065 Wall - Straight Ends
	51-18535-6		4" .065 Wall - Straight Ends
	51-80280-6	Reducer; Galvanized, 3" To 2" .065 Wall - Straight Ends	
	51-80281-6	Reducer; Galvanized, 4" To 2" .065 Wall - Straight Ends	
	51-18929-6	Reducer; Galvanized, 4" To 3" .065 Wall - Straight Ends	
	38-80297-6	Adapter; KM3 To KF2	
	38-43218-5	Adapter; DM4 To KF2	
	38-43219-5	Adapter; DM4 To KF3	
	38-80278-6	Coupling; Compression 2", 3 Bolt, Black Gasket, Grounding Strip	
	38-80279-6	Coupling; Compression 3", 3 Bolt, Black Gasket, Grounding Strip	
	38-13084-6	Coupling; Compression 4", 3 Bolt, Black Gasket, Grounding Strip	
	38-08786-6	Coupling; Compression 5", 3 Bolt, Black Gasket, Grounding Strip	
	38-08523-6	Coupling; Compression 6", 3 Bolt, Black Gasket, Grounding Strip	
	38-43216-5	Wand; 56", Steel W/KM2 Coupling	
	38-68000-5	Wand, Gaylord, 11ga X 51 " Aluminum W/KM2 Coupling	
	38-43217-5	Crevice Tool; 24" W/KM2 Coupling	
	38-18530-6	Gulper Tool; 13" Aluminum	
	38-40507-5	Squeegee Gulper Tool; 22" Aluminum	

Qty	Part Number	Description
	11-15427-6	Intake Filter, 13.75' Diameter x16" LG
	98-13813-5	Blower Oil, Walinga Super Duty, 4 Litre Jug
	38-72058-5	Squeegee Brush/Wand; 20" Brush Tool C/W Wand And Wheels
	11-47413-5	2" Tool & Hose Holder Rack
	11-83605-5	3" Tool & Hose Holder Rack
ft	36-75496-6	Hose, Flexhaust Clear, 2" w/Static Wire
ft	36-78277-6	Hose, Flexhaust Clear, 3" w/Static Wire
	36-78445-5	Hose, Flexhaust, 2" x 25" w/Static Wire & 2" Camlock KM2 1 End, KF2 Swivel 1 End
	36-91117-5	Hose, Flexhaust, 3" x 25" w/Static Wire & 3" Camlock KM3 1 End, KF3 Swivel 1 End
	36-98302-5	Hose, Flexhaust, 2" x 25" w/Static Wire & 2" Camlock Couplings
	36-78483-5	Hose, Flexhaust, 3" x 25" w/Static Wire & 3" Camlock Couplings
ft	73-82311-6	Hose; Rubber, 2" W/Static Wire
ft	36-15194-6	Hose; Rubber, 3" W/Static Wire
	36-41037-5	Hose; Rubber, 2" X 25' W/Static Wire & 2" Camlock Couplings
	36-40505-5	Hose; Rubber, 3" X 12' W/Static Wire & 3" Camlock Couplings
ft	89-80295-1	Tube; Steel-Aluminized, 2" OD. X .065" Wall
ft	89-16436-2	Tube; Aluminum, 2" OD. X .120 Wall
ft	89-80296-1	Tube; Steel-Aluminized, 3" OD. X .065" Wall
ft	89-15203-2	Tube; Aluminum, 3" OD. X .120 Wall
ft	89-17452-1	Tube; Galvanized, 4" OD. X .065" Wall
ft	89-00392-2	Tube; Aluminum, 4" OD. X .072 Wall
ft	89-08073-2	Tube; Aluminum, 5" OD. X .078 Wall
ft	89-16222-6	Tube; Aluminum, 6" OD. X .078 Wall
	38-18883-6	Coupling; 2", Camlock, Aluminum, Male, 2" ID (KM2-Tube)
	38-18152-6	Coupling; 3", Camlock, Aluminum, Male, 3" ID (KM3-Tube)
	38-18881-6	Coupling; 2", Camlock, Aluminum, Male, Hose Shank (KM2-Hose)
	38-13998-6	Coupling; 3", Camlock, Aluminum, Male, Hose Shank (KM3-Hose)
	38-00397-5	Coupling; 4", Walinga, Male, 4" ID (DM4-TUBE)
	38-18882-6	Coupling; 2", Camlock, Aluminum, Female, Hose Shank (KF2-Hose)
	38-13999-6	Coupling; 3", Camlock, Aluminum, Female, Hose Shank (KF3-Hose)
	38-19043-6	Coupling; 2", Camlock, Aluminum, Female, 2" ID (KF2-Tube)
	38-18153-6	Coupling; 3", Camlock, Aluminum, Female, 3" ID (KF3-Tube)
	38-36781-5	Coupling; 4", Walinga, Female, 4" ID (DF4-Tube)
	94-09185-5	Tailbolt; (2 Required For Each DF4 Coupling)
	38-18880-6	Dust Plug; 2" (KP2)
	38-13204-6	Dust Plug; 3" (KP3)
	38-04465-5	Dust Plug; 4" (DP4)
	28-16800-6	Clamp; Saddle, 2"
	28-04673-6	Clamp; Saddle, 3"
	28-02074-6	Clamp; Saddle, 4"
	28-04675-6	Clamp; Saddle, 5"
	38-39510-4	Bracket; Aluminum (For 4" Saddle Clamp)
	38-07612-6	1.25 Bin Standoff Bracket (For 3" - 6" Tube)
	38-65182-6	Tube Hanger, 3" Galvanized
	38-65183-6	Tube Hanger, 4" Galvanized
	30-75955-4	Airlock Tip, Flex, 1210 DT Hook-Up
	30-75957-4	Tip Clamp, 1210 Rotor, Short Tip

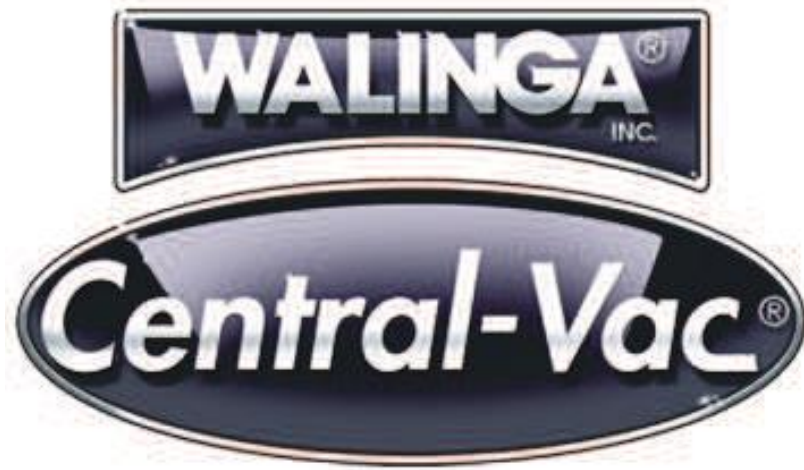

Central-Vac
Operator's Manual

WALINGA®

CORPORATE HEAD OFFICE:

5656 Highway 6N
RR#5, Guelph, Ontario, N1H 6J2
PHONE: (888) 925-4642 FAX: (519) 824-5651
www.walinga.com

AGRI-VAC MANUFACTURING FACILITY:

938 Glengarry Cres., Fergus, Ontario Canada N1M 2W7
Tel: (519) 787-8227 Fax: (519) 787-8210

DISTRIBUTION AND SERVICE CENTRES:

5656 Highway 6N, Guelph, Ontario Canada, N1H 6J2
Tel: (888) 925-4642 FAX: (519) 824-5651

1190 Electric Ave. Wayland, MI, USA 49348
Tel: (800) 466-1197 Fax: (616) 877-3474

70 3rd Ave. N.E. Box 1790 Carman, Manitoba Canada R0G 0J0
Tel: (204) 745-2951 Fax: (204) 745-6309

24 Molloy Street, Toowoomba, Queensland Australia 4350
Tel: 07-4634-7344 mail@customvac.com.au

PRINTED IN CANADA

ISSUE DATE: MAY 2015

OM PART# 34-19004-6 v7.2 06042019